

PYPLOK® Catalogue

PYPLOK®

F I T T I N G S

A Tube-Mac® Manufactured Product

**Non-Welded Mechanically
Attached Fittings**

Table of Contents

Introduction

Notice	A1
What is PYPLOK®	A2
Technology	A3
PYPLOK® System Benefits	A5
Industries and Applications	A6

Technical Information

Tube and Pipe Qualification	B1
PYPLOK® Pressure Ratings	
DM 20 Series – NPS Pipe	B2
DM 60 Series – OD Tube	B4
DM 80 Series – Metric Tube	B5
DM 80 Series – JIS Metric Tube	B7
DP 40 Series – NPS Low Pressure	B8
DP 04 Series – Metric Pipe CuNi	B8
Seal Selection	B9
Thread Size Charts	B10

DM 20 Series - NPS Pipe

General Characteristics	C1
Standard Fitting Configuration Guide	C2
Coupling, NPS - DM20001	C3
Coupling with Inner Stop, NPS - DM20002	C3
90° Elbow, NPS - DM20003	C4
45° Elbow, NPS - DM20017	C4
Tee, NPS - DM20004	C5
Reducing Tee, NPS - DM20104	C5
Reducer, NPS - DM20101	C6
End Cap, NPS - DM20085	C6
Flange – ANSI 150#, NPS - DM20018	C7
Flange – ANSI 300#, NPS - DM20019	C7
Flange – ANSI 600#, NPS - DM20027	C8
SAE Flange Body, NPS - DM20090	C8
SAE Code 61 Flange, NPS - DM20091	C9
SAE Code 62 Flange, NPS - DM20092	C9
SAE Code 61 Tapped Flange, NPS - DM20095	C10
SAE Code 62 Tapped Flange, NPS - DM20096	C10
JIC 37° Male, NPS - DM20055	C11
JIC 37° Female Swivel, NPS - DM20054	C11
NPT Male, NPS - DM20056	C12
NPT Female, NPS - DM20060	C12
SAE Male, NPS - DM20088	C13
SAE Female, NPS - DM20087	C13
BSPP Male, NPS - DM20153	C14
BSPP Female, NPS - DM20086	C14
ORFS Male, NPS - DM20010	C15
ORFS Female Swivel, NPS - DM20020	C15
Weldable Bulkhead, OD Tube - DM60089	C16
SAE Female Branch Tee, NPS - DM20171	C16
BSPP Female Branch Tee, NPS - DM20172	C17
NPT Female Branch Tee, NPS - DM20173	C17
Specialty Fitting Configuration Guide	C18

Table of Contents

DM 60 Series - OD Tube

General Characteristics	D1
Standard Fitting Configuration Guide	D2
Coupling, OD Tube - DM60001	D3
Coupling with Inner Stop, OD Tube - DM60002	D3
90° Elbow, OD Tube - DM60003	D4
45° Elbow, OD Tube - DM60017	D4
Tee, OD Tube - DM60004	D5
Reducing Tee, OD Tube - DM60104	D6
Reducer, OD Tube - DM60101	D7
End Cap, OD Tube - DM60085	D8
Flange – ANSI 150#, OD Tube - DM60018	D9
Flange – ANSI 300#, OD Tube - DM60019	D9
Flange – ANSI 600#, OD Tube - DM60027	D10
SAE Flange Body, OD Tube - DM60090	D10
SAE Code 61 Flange, OD Tube - DM60091	D11
SAE Code 62 Flange, OD Tube - DM60092	D11
SAE Code 61 Tapped Flange, OD Tube - DM60095	D12
SAE Code 62 Tapped Flange, OD Tube - DM60096	D12
JIC 37° Male, OD Tube - DM60055	D13
JIC 37° Female Swivel, OD Tube - DM60054	D13
NPT Male, OD Tube - DM60056	D14
NPT Female, OD Tube - DM60060	D14
SAE Male, OD Tube - DM60088	D15
SAE Female, OD Tube - DM60087	D15
BSPP Male, OD Tube - DM60153	D16
BSPP Female, OD Tube - DM60086	D16
ORFS Male, OD Tube - DM60010	D17
ORFS Female Swivel, OD Tube - DM60020	D17
Weldable Bulkhead, OD Tube - DM60089	D18
SAE Female Branch Tee, OD Tube - DM60171	D18
BSPP Female Branch Tee, OD Tube - DM60172	D19
NPT Female Branch Tee, OD Tube - DM60173	D19
Specialty Fitting Configuration Guide	D20

DM 80 Series - Metric Tube

General Characteristics	E1
Standard Fitting Configuration Guide	E2
Coupling, Metric - DM80001	E3
Coupling with Inner Stop, Metric - DM80002	E4
90° Elbow, Metric - DM80003	E5
45° Elbow, Metric - DM80017	E6
Tee, Metric - DM80004	E7
Reducing Tee, Metric - DM80104	E8
Reducer, Metric - DM80101	E9
End Cap, Metric - DM80085	E10
Flange – PN16, Metric - DM80028	E11
Flange – PN40, Metric - DM80029	E11
SAE Flange Body, Metric - DM80090	E12
ISO 6162-1 Flange, Metric - DM80091	E13
ISO 6162-2 Flange, Metric - DM80092	E13
ISO 6162-1 Tapped Flange, Metric - DM80095	E14
ISO 6162-2 Tapped Flange, Metric - DM80096	E14
JIC 37° Male, Metric - DM80055	E15
JIC 37° Female Swivel, Metric - DM80054	E15
BSPP Male, Metric - DM80153	E16
BSPP Female, Metric - DM80086	E17
DIN 24° Male, Metric - DM80066	E18
DIN 24° Female Swivel, Metric - DM80068	E19
Weldable Bulkhead, Metric - DM80089	E20
BSPP Female Branch Tee, Metric - DM80172	E21
BSPP Female Branch Tee, Metric – DM80211	E22

Table of Contents

DM 80 Series - Metric Tube, cont'd

BSPP (2) Port Female Branch Cross, Metric – DM80221	E23
BSPP (4) Port Female Branch Cross, Metric – BM80241	E24
Speciality Fitting Configuration Guide	E26

DM 80 Series - JIS Metric Tube

General Characteristics	E29
Standard Fitting Configuration Guide	E30
Coupling, Metric, JIS - DM80001	E31
Coupling with Inner Stop, Metric, JIS - DM80002	E31
90° Elbow, Metric, JIS - DM80003	E32
45° Elbow, Metric, JIS - DM80017	E32
Tee, Metric, JIS - DM80004	E33
End Cap, Metric, JIS - DM80085.....	E33
Speciality Fitting Configuration Guide	E34

DP 40N Series - NPS Low Pressure

General Characteristics	F1
Standard Fitting Configuration Guide	F2
Low Pressure Coupling, NPS - DP40N100	F3
Low Pressure 90° Elbow, NPS - DP40N300.....	F3
Low Pressure 45° Elbow, NPS - DP40N017	F4
Low Pressure Tee, NPS - DP40N400.....	F4
Low Pressure Reducing Tee, NPS - DP40N104	F5
Low Pressure Reducer, NPS - DP40N101	F5
Low Pressure End Cap, NPS - DP40N085	F6
Low Pressure Flange – ANSI 150#, NPS - DP40N018	F6
Low Pressure SAE Code 61 Flange, NPS - DP40N091.....	F7
Low Pressure SAE Code 61 Tapped Flange, NPS - DP40N095.....	F7

DP 40M Series - Metric Low Pressure

General Characteristics	G1
Standard Fitting Configuration Guide	G2
Coupling, Metric - DP40M100	G3
90° Elbow, Metric - DP40M300	G3
45° Elbow, Metric - DP40M017	G4
Tee, Metric - DP40M400.....	G4
End Cap, Metric - DP40M085	G5
Flange – ANSI #150, Metric - DP40M018	G5

PYPLOK® Tooling

The PYPLOK® Swaging Tooling System.....	H1
PYPLOK® Tooling Dimensions	
Model 10.....	H2
Model 20.....	H2
Model 40.....	H3
Model 55.....	H3
Model 70.....	H4
Model 86.....	H4
PYPLOK® Tooling Size Range Coverage.....	H5
PYPLOK® Tool Matrix	
DM 20 Series - NPS Pipe.....	H6
DM 60 Series - OD Tube.....	H7
DM 80 Series - Metric Tube.....	H8
DP 40N Series - NPS Low Pressure and DP 40M Series - Metric Low Pressure	H10
PYPLOK® Swaging Tool Pump Requirements	H11
Pumps Offered by Tube-Mac® for Use with the PYPLOK® Tooling	H11
PYPLOK® Tooling Accessories	H12

Table of Contents

Installation Procedures

PYPLOK® Swaging Tool Parts and Equipment.....	11
Pipe Preparation.....	12
Pipe Preparation - Special Notice	13
Verify Diameter of the Pipe Using the Inspection Gauge	14
Pipe Marking.....	14
Coupling Position and Alignment.....	15
Swage Sequence	16
Tool Operation and Die Engagement.....	17
Swage Inspection and Assembly.....	18
Swage and Installation Inspection.....	19

Appendix

PYPLOK® Limited Warranty.....	J1
-------------------------------	----

Introduction

Notice

The information and data presented in this catalogue is intended as reference for use of PYPLOK® equipment by designers and users for proper application and installation of the product. It is not intended to be used as a substitute for competent, professional assistance for any specific application.

While every effort has been made to ensure its accuracy, Tube-Mac®, its subsidiaries and affiliated companies, make no express or implied warranty of any kind regarding the information contained in this catalogue or the material referred within.

The technical and performance information such as weights, dimensions and ratings in this catalogue supersede all previous published data. Tube-Mac® is always striving for continual product improvement and developments and therefore reserves the right to change product designs, specifications and limitations without notice.

Anyone making use of the information or material contained herein does so at their own risk and assumes any and all liability resulting from such use.

All technical data presented should always be used to design a system along with good piping practices. The pressure, temperature and other limiting factors of the PYPLOK® product must never be exceeded. For any additional technical information, it is recommended to contact Tube-Mac®.



Introduction

What is PYPLOK®

PYPLOK® is a 360° radial swage mechanically attached fitting which permanently connects pipe and tube for a leak free, cold connection. The system is fast, reliable and tamper proof ideal for use in new build and maintenance works where fire hazards exist and a clean piping connection is required. A hydraulically powered compression tool swages the fitting over pipe/tube plastically deforming the fitting in seconds. The fitting can be used in a wide variety of low to high pressure piping applications in industries such as Marine & Offshore, Navy, Oil & Gas, Petrochemical, Steel, Mining and other Industrial uses.



This technology was originally developed in 1968 by McDonnell Aircraft as a replacement to threaded and brazed joints on the F-4 Fighter Jet. Threaded and brazed joints were less reliable in applications of high stresses and loads so they developed the 360° Radial Swage technology. McDonnell Aircraft licensed a company, Deutsch Metal Components (DMC) to manufacture this new fitting technology specifically for aerospace tubing application. In 1978, DMC expanded the range of the product to Nominal Bore Pipe, OD Tube and Metric Tube for industrial applications in the Oil & Gas, Marine & Offshore, Navy and Industrial Process and Power Piping industries. As an equal or better equivalent to welding and threading it was accepted as a new alternative to connecting pipes and tubes.

In 2007, DMC decided to divest in the industrial line of Mechanically Attached Fittings and sell the product line to one of its largest users which was Tube-Mac®. Since then Tube-Mac® has integrated PYPLOK® into their large offering of non-welded piping solutions and has expanded the range to additional materials, configurations and sizes.

Introduction

Technology

PYPLOK® Fittings incorporates a unique sealing capability by using four non-metallic O-Rings which compress against the pipe surface which produces a leak tight, permanent seal. Due to the use of O-Rings, the fitting is able to be installed on normal pipe and tube tolerances and surface conditions.

The PYPLOK® connector is a metal sleeve which slides over the pipe or tube. The outer diameter at each end of the connector is then swaged against the pipe or tube using a hand held portable hydraulic tool. The tool transfers a linear force of 360° radial force which results in a permanent leak free connection. At each swaged end there is an internal helical ridge which, when swaged, penetrates the outer surface of the pipe or tube. Axial grooves separate the ridge into teeth which resist torsional loads.

There are two O-Ring seals. The “Inner Main Seal” is the high pressure seal. The O-Ring groove which houses this main seal has an annular ridge directly beside the groove which provides additional support upon swaging assuring a fluid tight connection. At the outer end of the fitting is the second O-Ring groove which houses the “Outer Environmental Seal”. This seal prevents the ingress of fluids and/or contaminants from entering between the fitting and the tube thereby preventing internal corrosion.

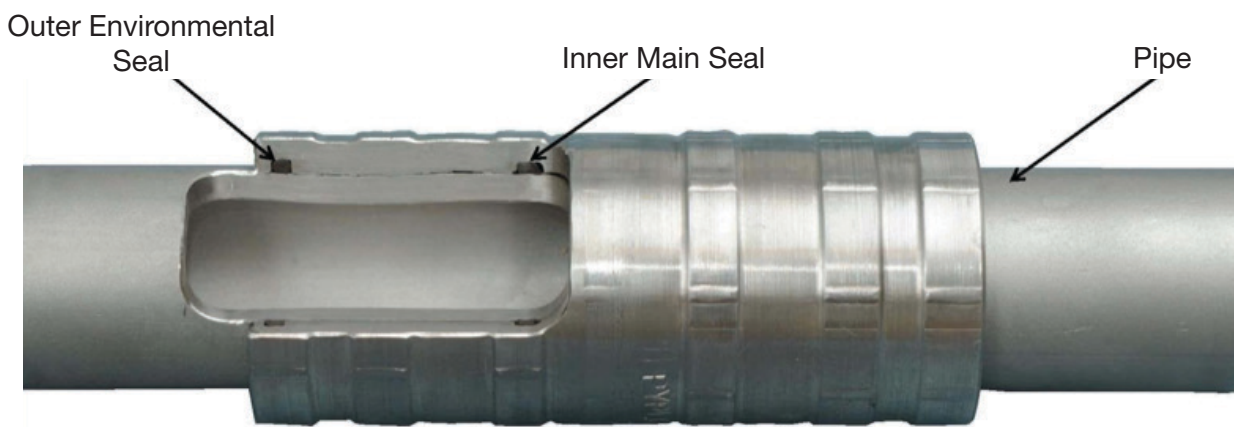

PYPLOK® has been mechanically and environmentally tested according to many standards and procedures over the years. PYPLOK® has passed combined impulse and vibration tests as well as shock and fire tests. PYPLOK® was analyzed using FEA (Finite Element Analysis) to ensure compliance under ASME B31.1, 31.3, 31.4 & 31.8. Below are some of the type approvals and standards to which PYPLOK® complies:

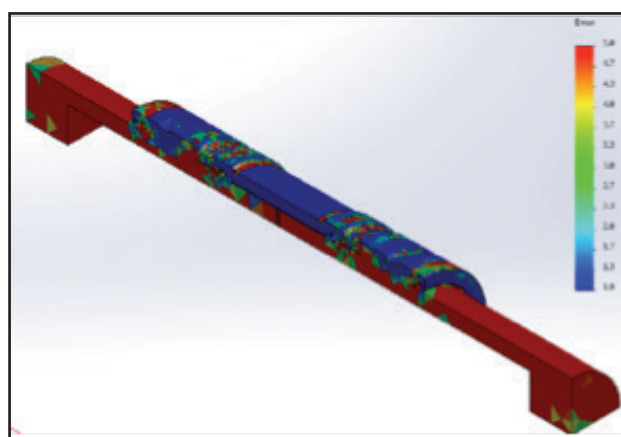
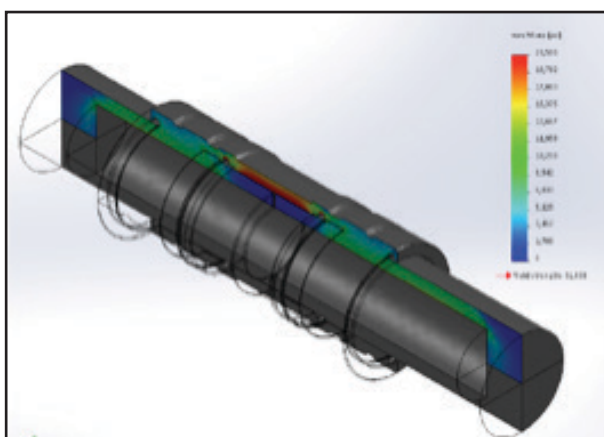

Introduction



ASME B31.1, 31.3, 31.4 & 31.8 Qualified

CRN – Canadian Registration No. 0A12153.5

API 6FB and ISO 19921/15540 Fire Test

NAVSEA and USCG Approved

ABS, DNV, Lloyd's, CCS, RMRS & BV Type Approved

The installation and subsequent inspection of fittings is the most expensive part of joining and maintaining any piping system. Regardless of the type of piping system, there may be numerous threaded, welded and brazed fittings. These traditional types of fittings are costly to install as they are more labour intensive.

Expensive and laborious procedures may include the following:

- Obtaining permits
- Inspection of joint
- Rework of joints that do not pass inspection
- Preparation time
- Hydrostatic testing
- Time for welding or brazing
- Fit-up time
- Purging the system
- Need for a fire watch

PYPLOK® Mechanically Attached Fitting System is the best alternative to threaded, welded, or brazed joints.

Some of the many advantages of using PYPLOK® over traditional methods are:

- There is no need to purge or flush the piping system of gas or liquid because the application of PYPLOK® requires no hot work. In other words, PYPLOK® is installed cold.
- The time required to join the pipe ends together is significantly shorter because of the portable tools used to compress the fitting onto the pipe.
- Reduced inspection time through an inspection gauge, which checks for proper swaged diameter to determine satisfactory compression of the fitting. This eliminates the need for conventional NDT requirements such as X-rays etc.
- There is no need for fire watch or any special fire permit which are needed for welding or brazing, as there are no fumes or fire hazards when installing PYPLOK®.
- PYPLOK® is a safe cold work technology.

With all the advantages listed above, PYPLOK® is certainly the most economical and efficient way of joining pipes. It dramatically reduces costs, greatly enhances quality and significantly improves safety conditions and reliability of the completed joint.

Introduction

PYPLOK® fittings come in all standard configurations (straights, 45° & 90° elbows, adapter, tees, reducers and flanged ends).

PYPLOK® configurations provide permanent ends or a combination of permanent and separable ends. Separable ends include ANSI, SAE and ISO Flanged as well as JIC 37°, ORFS, NPT, BSPP and DIN 24° fittings.

PYPLOK® fittings are available in Carbon Steel, Stainless Steel and Copper Nickel (CuNi), Duplex and Super Duplex.

PYPLOK® is suitable for NPS pipes, OD tubes and Metric tubes.

PYPLOK® System Benefits

PYPLOK® system assists you and your team with safe and cost effective work practices

Most cost effective on-site pipe work fabrication and repairs

- Reduces on-site time and labour; PYPLOK® fittings are swaged on cold, hot work permits are no longer required. PYPLOK® tooling is hydraulically actuated removing the need for special site services.
- PYPLOK® system prevents the need for Gas Freeing, System Flushing, NDT, and Fire Watch; designed as a one person operation.
- Swaged fittings are verified with an inspection gauge - much quicker than NDT.

Provides an improved safety environment

- The PYPLOK® system, developed to reduce hot work, is in itself a safe system. There are no torches, open flames or sparks associated with the installation or maintenance.

PYPLOK® system on EVERY installation achieves

- Improved productivity; many tasks carried out in only one-shift with minimum disruption to production.
- Installed cost reduction of up to 60%.

PYPLOK® system on EVERY installation offers

- High tensile and high torque hold.
- Minimum pipe preparation.

Requires very little specialized skill and training

- PYPLOK® system provides a range of fittings and hand-held tooling that requires a minimum of specialized skills to install - easy and user friendly.
- Training takes less than 30-minutes to complete.
- Fully detailed, simple to follow documentation (Installation and Preventative Maintenance Manuals including Inspection Criteria Instructions) are provided with each purchased kit.

How much does it cost - rent or buy?

- Clients have recuperated tooling and fitting costs in one system installation.
- Tooling Rental Program and or Purchase Programs Available.

Introduction

Industries and Applications

PYPLOK® has been used in numerous industries worldwide including but not limited to:

- Ship Building and Repair (Commercial and Navy)
- Refinery, Chemical, Pharmaceuticals, Food/Beverage
- Marine, Offshore and Sub Sea
- Land Based Drilling Rigs, Mobile Equipment
- Sugar, Steel/Metal Production, Testing Equipment, Fire Suppression
- Mining, Pulp and Paper, Nuclear/Power Generation, Automotive

PYPLOK® Applications Include:

- CNG – Compressed Natural Gas
- CO2 Cofferdam Inerting
- Condensate Piping
- Deluge Systems
- Down Well Coiled Tubing
- Drains and Plumbing Vent
- Ethylene Glycol/Water
- Fuel and Fuel Heating Lines
- Heating Coils
- Utility Piping Systems
- High Pressure Fire Suppression Systems
- Mobile Equipment Tubing/Piping
- High Pressure Hydraulics Systems
- Low Temperature Steam (<200°C)
- LPG – Liquefied Petroleum Gas
- Lubrication & Grease
- Natural Gas Distribution
- Plant, Instrumentation and Utility Air
- Waste Systems
- Solvents and Water Based Paints
- Subsea/BOP Piping
- Steam Tracer Lines
- Waste Water
- Paint, Brake Fluid and Sealer Lines

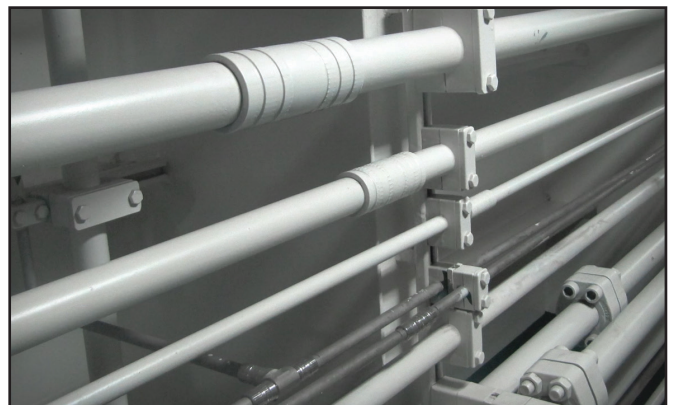
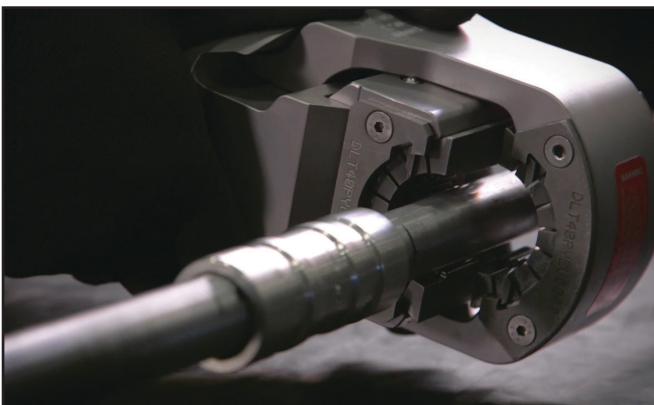

Tube and Pipe Qualification

DM 20 Series - NPS Pipe		
Size	Min. Wall	Max. Wall
1/4"	Sch.10	Sch.80
3/8"	Sch.10	Sch.80
1/2"	Sch.10	Sch.80
3/4"	Sch.10	Sch.80
1"	Sch.10	Sch.160
1-1/4"	Sch.10	Sch.160
1-1/2"	Sch.10	Sch.160
2"	Sch.10	Sch.160
3"	Sch.80	Sch.160

DM 80 Series - JIS Metric Tube			
Size	OD	Min. Wall	Max. Wall
06A	10.50mm	1.00mm	3.00mm
08A	13.80mm	1.00mm	3.00mm
10A	17.30mm	1.00mm	3.20mm
15A	21.70mm	1.00mm	4.00mm
20A	27.20mm	2.00mm	4.00mm
25A	34.00mm	2.00mm	6.40mm
32A	42.70mm	3.00mm	6.40mm
40A	48.60mm	3.00mm	7.14mm
50A	60.50mm	3.00mm	8.71mm

DM 60 Series - OD Tube		
Size	Min. Wall	Max. Wall
1/4"	0.028"	0.083"
3/8"	0.028"	0.095"
1/2"	0.035"	0.120"
5/8"	0.035"	0.120"
3/4"	0.049"	0.180"
1"	0.049"	0.180"
1-1/4"	0.065"	0.220"
1-1/2"	0.065"	0.220"
2"	0.065"	0.220"

DP 40N Series - NPS Low Pressure		
Size	Min. Wall	Max. Wall
2-1/2"	Sch.10	Sch.80
3"	Sch.10	Sch.80
4"	Sch.10	Sch.80

DP 40M Series - Metric Pipe CuNi Tube		
Size	Min. Wall	Max. Wall
44.5mm	1mm	3mm
57mm	1mm	3mm
76mm	1mm	3mm

DM 80 Series - Metric Tube		
Size	Min. Wall	Max. Wall
6mm	1mm	2mm
8mm	1mm	2mm
10mm	1mm	3mm
12mm	1mm	3mm
15mm	1mm	3mm
16mm	1mm	3mm
18mm	1mm	3mm
20mm	1mm	4mm
22mm	1mm	4mm
25mm	2mm	4mm
28mm	2mm	4mm
30mm	2mm	4mm
35mm	2mm	4mm
38mm	3mm	5mm
42mm	3mm	5mm
50mm	3mm	5mm
60mm	3mm	8mm

Allowable Outside Pipe/Tube Diameter Tolerances for PYPLOK®		
NPS Pipe	1/4" to 1-1/2"	+/- 0.015" (0.381mm)
	2" - 4"	+/- 0.030" (0.762mm)
OD Tube	1/4" to 3/8"	+/- 0.005" (0.127mm)
	1/2" to 1-1/2"	+/- 0.010" (0.254mm)
	2"	+/- 0.015" (0.381mm)
Metric Tube	6mm to 38mm	+/- 0.254mm (0.010")
	42mm to 60mm	+/- 0.381mm (0.015")
JIS Metric Tube	06A - 25A	+/- 0.254mm (0.010")
	32A - 50A	+/- 0.381mm (0.015")

*Qualified Pipe/Tube		
Stainless Steel PYPLOK®	Carbon Steel PYPLOK®	Copper Nickel PYPLOK®
ASTM A312/A269 (304/304L/316/316L) EN 10216-5 (304/304L/316/316L) EN10305-4 (E355N/ST52.4)	ASTM A106 Gr. A/B/C A53 ERW Gr. A/B EN10305-4 (E355N/E235N/ST52.4/ST37.4) API 5L Seamless/ERW ASTM A333 Gr.6	MIL-T-16420 (70/30 & 90/10)

*As there are numerous pipe/tube specs, not every spec has been listed. If you do not see your spec please consult the factory to confirm pipe/tube qualification.

2" NPS DM 20 Series Carbon Steel PYPLOK® cannot be used on EN 10305-4 (E355N/ST52.4) pipe/tube but as replacement 2" NPS DM 20 Series Stainless Steel PYPLOK® or 60mm DM 80 Series Carbon Steel PYPLOK® can be used.

PYPLOK® Standard Pressure Ratings

DM 20 Series – NPS Pipe

Pressure Ratings are based on system temperatures of -15°F to 400°F (-26°C to 205°C) and are limited to the maximum rating of the adjoining tube and/or end connection. Consideration must be taken on PYPLOK® Pressure Ratings and adjoining connection with the lower rated end being the limiting factor.

Stainless Steel Pressure Ratings				
Size NPS	4:1 Safety Factor		3:1 Safety Factor	
	PSI	bar	PSI	bar
1/4"	6000	415	8000	552
3/8"	6000	415	8000	552
1/2"	5900	407	7866	543
3/4"	5800	400	7733	533
1"	5700	393	7600	524
1-1/4"	5650	390	7533	520
1-1/2"	5650	390	7533	520
2"	4800	330	6400	441
3"	2625	180	3500	240

Carbon Steel Pressure Ratings				
Size NPS	4:1 Safety Factor		3:1 Safety Factor	
	PSI	bar	PSI	bar
1/4"	5000	345	6667	460
3/8"	5000	345	6667	460
1/2"	4917	339	6555	452
3/4"	4833	333	6444	444
1"	4750	328	6333	437
1-1/4"	4710	325	6278	433
1-1/2"	4710	325	6278	433
2"	4000	276	5333	368
3"	2625	180	3500	240

Copper Nickel Pressure Ratings				
Size NPS	4:1 Safety Factor		3:1 Safety Factor	
	PSI	bar	PSI	bar
1/4"	3896	269	5195	358
3/8"	3896	269	5195	358
1/2"	3831	264	5108	352
3/4"	3766	260	5022	346
1"	3701	255	4935	340
1-1/4"	3669	253	4892	337
1-1/2"	3669	253	4892	337
2"	3117	215	4156	287

PYPLOK® Pressure Ratings According to ASME B31.1 & ASME B31.3

DM 20 Series – NPS Pipe

Pressure Ratings are based on system temperatures that are listed below and are limited to the maximum rating of the adjoining tube and/or end connection. Consideration must be taken on PYPLOK® Pressure Ratings and adjoining connection with the lower rated end being the limiting factor.

Stainless Steel Pressure Ratings				
Size NPS	ASME B31.1 (PSI)			
	-20°F to 100°F	200°F	300°F	400°F
1/4"	5800	5800	5800	5600
3/8"	5600	5600	5600	5400
1/2"	5400	5400	5400	5200
3/4"	5100	5100	5100	5000
1"	4800	4800	4800	4700
1-1/4"	4400	4400	4400	4200
1-1/2"	4200	4200	4200	4000
2"	3700	3700	3700	3600

Carbon Steel Pressure Ratings				
Size NPS	ASME B31.1 (PSI)			
	-20°F to 100°F	200°F	300°F	400°F
1/4"	5200	5200	5200	5200
3/8"	5000	5000	5000	5000
1/2"	4900	4900	4900	4900
3/4"	4700	4700	4700	4700
1"	4400	4400	4400	4400
1-1/4"	4100	4100	4100	4100
1-1/2"	3900	3900	3900	3900
2"	3500	3500	3500	3500

Stainless Steel Pressure Ratings				
Size NPS	ASME B31.3 (PSI)			
	-20°F to 100°F	200°F	300°F	400°F
1/4"	5800	5800	5800	5600
3/8"	5600	5600	5600	5400
1/2"	5400	5400	5400	5200
3/4"	5100	5100	5100	5000
1"	4800	4800	4800	4700
1-1/4"	4400	4400	4400	4200
1-1/2"	4200	4200	4200	4000
2"	3700	3700	3700	3600

Carbon Steel Pressure Ratings				
Size NPS	ASME B31.3 (PSI)			
	-20°F to 100°F	200°F	300°F	400°F
1/4"	5200	4900	4700	4500
3/8"	5000	4800	4600	4400
1/2"	4900	4600	4400	4300
3/4"	4700	4400	4200	4100
1"	4400	4200	4000	3900
1-1/4"	4100	3900	3700	3600
1-1/2"	3900	3700	3500	3400
2"	3500	3300	3100	3000

PYPLOK® Standard Pressure Ratings

DM 60 Series – OD Tube

Pressure Ratings are based on system temperatures of -15°F to 400°F (-26°C to 205°C) and are limited to the maximum rating of the adjoining tube and/or end connection. Consideration must be taken on PYPLOK® Pressure Ratings and adjoining connection with the lower rated end being the limiting factor.

Stainless Steel Pressure Ratings				
Size OD	4:1 Safety Factor		3:1 Safety Factor	
	PSI	bar	PSI	bar
1/4"	7000	483	9333	644
3/8"	5800	400	7733	533
1/2"	6100	420	8133	561
5/8"	6100	420	8133	561
3/4"	6000	414	8000	552
1"	5800	400	7733	533
1-1/4"	5800	400	7733	533
1-1/2"	5650	390	7533	520
2"	4800	330	6400	441

Carbon Steel Pressure Ratings				
Size OD	4:1 Safety Factor		3:1 Safety Factor	
	PSI	bar	PSI	bar
1/4"	5833	402	7778	536
3/8"	4833	333	6444	444
1/2"	5100	350	6778	467
5/8"	5100	350	6778	467
3/4"	5000	345	6667	460
1"	4833	333	6444	444
1-1/4"	4833	333	6444	444
1-1/2"	4710	325	6278	433
2"	4000	275	5333	368

Copper Nickel Pressure Ratings				
Size OD	4:1 Safety Factor		3:1 Safety Factor	
	PSI	bar	PSI	bar
1/4"	4545	313	6060	418
3/8"	3766	260	5022	346
1/2"	3961	273	5281	364
5/8"	3961	273	5281	364
3/4"	3896	269	5195	358
1"	3766	260	5022	346
1-1/4"	3766	260	5022	346
1-1/2"	3669	253	4892	337
2"	3117	215	4156	287

PYPLOK® Standard Pressure Ratings

DM 80 Series – Metric Tube

Pressure Ratings are based on system temperatures of -15°F to 400°F (-26°C to 205°C) and are limited to the maximum rating of the adjoining tube and/or end connection. Consideration must be taken on PYPLOK® Pressure Ratings and adjoining connection with the lower rated end being the limiting factor.

Stainless Steel Pressure Ratings				
Size OD (mm)	4:1 Safety Factor		3:1 Safety Factor	
	PSI	bar	PSI	bar
6	6500	450	8665	600
8	6200	430	8265	570
10	6000	415	8000	550
12	5800	400	7735	535
15	5800	400	7735	535
16	5800	400	7735	535
18	4500	310	6000	415
20	5650	390	7535	520
22	4425	305	5900	405
25	5650	390	7535	520
28	4350	300	5800	400
30	5650	390	7535	520
35	4275	295	5700	395
38	5650	390	7535	520
42	5650	390	7535	520
50	5100	350	6800	470
60	4800	330	6400	440

Carbon Steel Pressure Ratings				
Size OD (mm)	4:1 Safety Factor		3:1 Safety Factor	
	PSI	bar	PSI	bar
6	5420	375	7225	500
8	5170	355	6890	475
10	5000	345	6670	460
12	4835	335	6445	445
15	4835	335	6445	445
16	4835	335	6445	445
18	3750	260	5000	345
20	4710	325	6280	435
22	3690	255	4920	340
25	4710	325	6280	435
28	3625	250	4835	335
30	4710	325	6280	435
35	3560	245	4750	325
38	4710	325	6280	435
42	4710	325	6280	435
50	4250	295	5670	390
60	4000	275	5335	370

PYPLOK® Standard Pressure Ratings

DM 80 Series – Metric Tube

Pressure Ratings are based on system temperatures of -15°F to 400°F (-26°C to 205°C) and are limited to the maximum rating of the adjoining tube and/or end connection. Consideration must be taken on PYPLOK® Pressure Ratings and adjoining connection with the lower rated end being the limiting factor.

Copper Nickel Pressure Ratings				
Size OD (mm)	4:1 Safety Factor		3:1 Safety Factor	
	PSI	bar	PSI	bar
6	4220	290	5630	390
8	4025	280	5370	370
10	3895	270	5195	360
12	3765	260	5025	345
16	3765	260	5025	345
20	3670	255	4895	335
25	3670	255	4895	335
30	3670	255	4895	335
38	3670	255	4895	335
42	3670	255	4895	335
50	3315	230	4415	305
60	3120	215	4155	285

PYPLOK® Standard Pressure Ratings

DM 80 Series – JIS Metric Tube

Pressure Ratings are based on system temperatures of -15°F to 400°F (-26°C to 205°C) and are limited to the maximum rating of the adjoining tube and/or end connection. Consideration must be taken on PYPLOK® Pressure Ratings and adjoining connection with the lower rated end being the limiting factor.

Stainless Steel Pressure Ratings				
JIS Size	4:1 Safety Factor		3:1 Safety Factor	
	PSI	bar	PSI	bar
06A	3750	260	5000	347
08A	3750	260	5000	347
10A	3750	260	5000	347
15A	3690	255	4920	340
20A	3625	250	4833	333
25A	3560	245	4747	327
32A	3750	260	5000	347
40A	3750	260	5000	347
50A	3750	260	5000	347

Carbon Steel Pressure Ratings				
JIS Size	4:1 Safety Factor		3:1 Safety Factor	
	PSI	bar	PSI	bar
06A	3750	260	5000	347
08A	3750	260	5000	347
10A	3750	260	5000	347
15A	3690	255	4920	340
20A	3625	250	4833	333
25A	3560	245	4747	327
32A	3750	260	5000	347
40A	3750	260	5000	347
50A	3750	260	5000	347

Copper Nickel Pressure Ratings				
JIS Size	4:1 Safety Factor		3:1 Safety Factor	
	PSI	bar	PSI	bar
06A	3750	260	5000	347
08A	3750	260	5000	347
10A	3750	260	5000	347
15A	3670	253	4893	337
20A	3625	250	4833	333
25A	3670	253	4893	337
32A	3315	230	4420	307
40A	3315	230	4420	307
50A	3120	215	4160	287

PYPLOK® Standard Pressure Ratings

DP 40N Series – NPS Low Pressure

Pressure Ratings are based on system temperatures of -15°F to 400°F (-26°C to 205°C) and are limited to the maximum rating of the adjoining tube and/or end connection. Consideration must be taken on PYPLOK® Pressure Ratings and adjoining connection with the lower rated end being the limiting factor.

Stainless Steel Pressure Ratings				
Size NPS	4:1 Safety Factor		3:1 Safety Factor	
	PSI	bar	PSI	bar
2-1/2"	500	35	665	45
3"	500	35	665	45
4"	500	35	665	45

Carbon Steel Pressure Ratings				
Size NPS	4:1 Safety Factor		3:1 Safety Factor	
	PSI	bar	PSI	bar
2-1/2"	500	35	665	45
3"	500	35	665	45
4"	500	35	665	45

Copper Nickel Pressure Ratings				
Size NPS	4:1 Safety Factor		3:1 Safety Factor	
	PSI	bar	PSI	bar
2-1/2"	365	25	495	34
3"	365	25	495	34

DP 40M Series – Metric Pipe Low Pressure

Pressure Ratings are based on system temperatures of -15°F to 400°F (-26°C to 205°C) and are limited to the maximum rating of the adjoining tube and/or end connection. Consideration must be taken on PYPLOK® Pressure Ratings and adjoining connection with the lower rated end being the limiting factor.

Copper Nickel Pressure Ratings				
Size OD (mm)	4:1 Safety Factor		3:1 Safety Factor	
	PSI	bar	PSI	bar
44.5	450	31	600	42
57	450	31	600	42

Seal Selection

PYPLOK® Fittings are offered with two types of standard seal materials which cover a very broad range of temperatures and compatibility with numerous fluids and gases. The standard seals are VITON and EPDM, both having large application range but many other seal material grades are available to meet specific application requirements. It is the responsibility of the end user to ensure that the seals in the fittings are compatible with the piping system medium and temperature limits. Consult the factory for confirmation of seal compatibility for each system intending to use PYPLOK®. The table below is intended as a reference only for basic guidance to the typical mediums each seal material is appropriate for.

VITON	
Recommended For	Not Recommended For
Petroleum, Mineral and Vegetable Oils Silicone Oils and Grease Aromatic Hydrocarbons (Benzene, Toluene) Chlorinated Hydrocarbons Hydraulic Fluids Solvents and Chemicals	Hot Water and Steam Auto and Brake Fluids Amines Ketones Low Molecular Weight Esters and Ethers

EPDM	
Recommended For	Not Recommended For
Hot Water and Steam Glycol Based Brake Fluids Organic and Inorganic Acids Cleaning Agents, Soda and Potassium Alkalis Phosphate – Ester Hydraulic Fluids Polar Solvents (Alcohols, Ketones, Esters)	Mineral Oil Products Hydrocarbons Greases and Oils

Thread Size Charts

Dash Thread Size								
Size	4	6	8	12	16	20	24	32
JIC	7/16-20	9/16-18	3/4-16	1 1/16-12	1 5/16-12	1 5/8-12	1 7/8-12	2 1/2-12
NPT	1/4-18	3/8-18	1/2-14	3/4-14	1-11 1/2	1 1/4-11 1/2	1 1/2-11 1/2	2-11 1/2
SAE	7/16-20	9/16-18	3/4-16	1 1/16-12	1 5/16-12	1 5/8-12	1 7/8-12	2 1/2-12
BSPP	1/4-19	3/8-19	1/2-14	3/4-14	1-11	1 1/4-11	1 1/2-11	2-11
ORFS	9/16-18	11/16-16	13/16-16	1 3/16-12	1 7/16-12	1 11/16-12	2-12	N/A

Metric Thread Size "S"									
Size	6S	8S	10S	12S	16S	20S	25S	30S	38S
DIN 2353	M14 x 1.5	M16 x 1.5	M18 x 1.5	M20 x 1.5	M24 x 1.5	M30 x 2.0	M36 x 2.0	M42 x 2.0	M52 x 2.0

Metric Thread Size "L"										
Size	6L	8L	10L	12L	15L	18L	22L	28L	35L	42L
ISO 8434-1	M12 x 1.5	M14 x 1.5	M16 x 1.5	M18 x 1.5	M22 x 1.5	M26 x 1.5	M30 x 2.0	M36 x 2.0	M45 x 2.0	M52 x 2.0

General Characteristics

DM 20 Series - NPS Pipe

Fitting Material Specifications

K = Stainless Steel
 G = Carbon Steel
 B = Copper Nickel 70/30
 C = Copper Nickel 90/10
 D = Duplex
 Z = Super Duplex

Material Specification

ASTM-A479/A182-316
 ASTM-A105/A350 LF2
 MIL-C71500
 MIL-C70600
 ASTM-A479/A182-UNS31803
 ASTM-A479/A182-UNS32750

2" NPS DM 20 Series Carbon Steel PYPLOK® cannot be used on EN 10305-4 (E355N/ST52.4) pipe/tube but as replacement 2" NPS DM 20 Series Stainless Steel PYPLOK® or 60mm DM 80 Series Carbon Steel PYPLOK® can be used.

O-Ring Material Specifications

VITON (Brown Colour)
 EPDM (Black Colour)

O-Ring Temperature Limits

-15°F to 400°F (-26°C to 205°C)
 -60°F to 400°F (-51°C to 205°C)

For seal compatibility and selection for each system consult factory. Other seal materials for specific applications of compatibility and temperature are available upon request.

Ordering Information

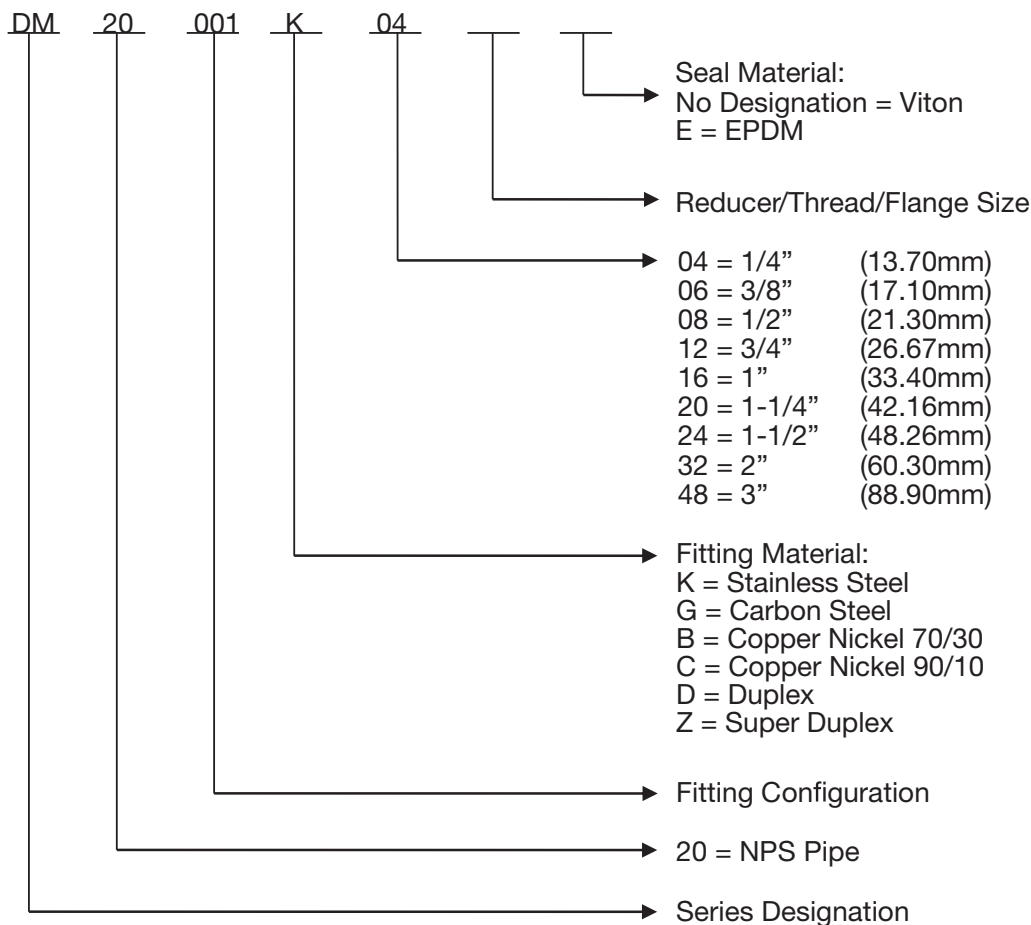











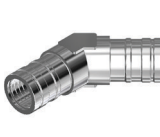



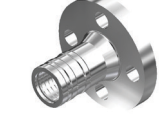







System design and safe application is the responsibility of the end-user. Consideration must be taken to confirm proper fitting selection is made to ensure proper compatibility, function and operation of the fitting within the piping system. The technical and performance information such as weights, dimensions and ratings in this catalogue supersede all previous published data. Tube-Mac® reserves the right to change technical data and product dimension, ratings and other aspects without notice.

Standard Fitting Configuration Guide

DM 20 Series - NPS Pipe

1/4" to 3"

					
Coupling DM20001 Page C3	Coupling with Inner Stop DM20002 Page C3	90° Elbow DM20003 Page C4	45° Elbow DM20017 Page C4	Tee DM20004 Page C5	Reducing Tee DM20104 Page C5
					
Reducer DM20101 Page C6	End Cap DM20085 Page C6	Flange - ANSI 150# DM200018 Page C7	Flange - ANSI 300# DM20019 Page C7	Flange - ANSI 600# DM20027 Page C8	SAE Flange Body DM20090 Page C8
					
SAE Code 61 Flange DM20091 Page C9	SAE Code 62 Flange DM20092 Page C9	SAE Code 61 Tapped Flange DM20095 Page C10	SAE Code 62 Tapped Flange DM20096 Page C10	JIC 37° Male DM20055 Page C11	JIC 37° Female Swivel DM20054 Page C11
					
NPT Male DM20056 Page C12	NPT Female DM20060 Page C12	SAE Male DM20088 Page C13	SAE Female DM20087 Page C13	BSPP Male DM20153 Page C14	BSPP Female DM20086 Page C14
					
ORFS Male DM20010 Page C15	ORFS Female Swivel DM20020 Page C15	Weldable Bulkhead DM60089 Page C16	SAE Female Branch Tee DM20171 Page C16	BSPP Female Branch Tee DM20172 Page C17	NPT Female Branch Tee DM20173 Page C17

DM 20 Series - NPS Pipe

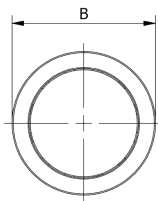
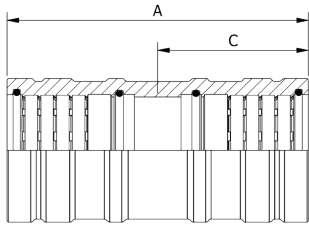

***MATERIAL CODE:**
 K = STAINLESS STEEL
 G = CARBON STEEL
 B = COPPER NICKEL 70/30

ORDER EXAMPLE:
 DM20001G04

Coupling, NPS - DM20001

Size NPS	Part Number	Dimensions - Inch (mm)			*Weight K & G lbs (kg)
		A	B	C Insertion Depth	
1/4"	DM20001*04	2.25 (57.15)	0.80 (20.32)	1.13 (28.70)	0.12 (0.05)
3/8"	DM20001*06	2.75 (69.85)	0.99 (25.15)	1.38 (35.05)	0.25 (0.11)
1/2"	DM20001*08	3.00 (76.20)	1.20 (30.48)	1.50 (38.10)	0.44 (0.20)
3/4"	DM20001*12	3.50 (88.90)	1.48 (37.59)	1.75 (44.45)	0.61 (0.28)
1"	DM20001*16	4.00 (101.60)	1.82 (46.23)	2.00 (50.80)	1.07 (0.49)
1-1/4"	DM20001*20	4.75 (120.65)	2.26 (57.40)	2.38 (60.45)	2.00 (0.91)
1-1/2"	DM20001*24	5.00 (127.00)	2.58 (65.53)	2.50 (63.50)	2.78 (1.26)
2"	DM20001*32	7.00 (177.80)	3.04 (77.22)	3.50 (88.90)	4.40 (2.00)
3"	DM20001*48	10.00 (254.00)	4.38 (111.25)	5.00 (127.00)	14.06 (6.38)

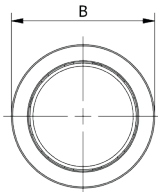
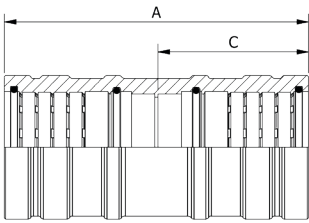

***MATERIAL CODE:**
 K = STAINLESS STEEL
 G = CARBON STEEL
 B = COPPER NICKEL 70/30

ORDER EXAMPLE:
 DM20002G04

Coupling with Inner Stop, NPS - DM20002

Size NPS	Part Number	Dimensions - Inch (mm)			*Weight K & G lbs (kg)
		A	B	C Insertion Depth	
1/4"	DM20002*04	2.30 (58.42)	0.80 (20.32)	1.13 (28.70)	0.12 (0.05)
3/8"	DM20002*06	2.80 (71.12)	0.99 (25.15)	1.38 (35.05)	0.25 (0.11)
1/2"	DM20002*08	3.05 (77.47)	1.20 (30.48)	1.50 (38.10)	0.35 (0.16)
3/4"	DM20002*12	3.55 (90.17)	1.48 (37.59)	1.75 (44.45)	0.61 (0.28)
1"	DM20002*16	4.05 (102.87)	1.82 (46.23)	2.00 (50.80)	1.07 (0.49)
1-1/4"	DM20002*20	4.80 (121.92)	2.26 (57.40)	2.38 (60.45)	1.96 (0.89)
1-1/2"	DM20002*24	5.05 (128.27)	2.58 (65.53)	2.50 (63.50)	2.78 (1.26)
2"	DM20002*32	7.05 (179.07)	3.04 (77.22)	3.50 (88.90)	4.40 (2.00)
3"	DM20002*48	10.05 (255.27)	4.38 (111.25)	5.00 (127.00)	12.21 (5.54)

3D step models available upon request

DM 20 Series - NPS Pipe

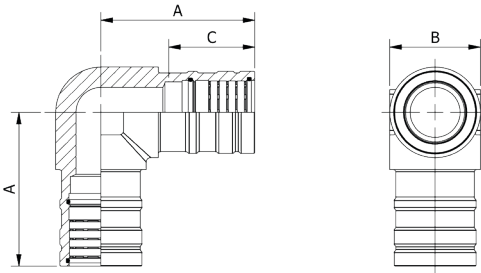

***MATERIAL CODE:**
 K = STAINLESS STEEL
 G = CARBON STEEL
 B = COPPER NICKEL 70/30

ORDER EXAMPLE:
 DM20003G04

90° Elbow, NPS - DM20003

Size NPS	Part Number	Dimensions - Inch (mm)			*Weight K & G lbs (kg)
		A	B	C Insertion Depth	
1/4"	DM20003*04	1.75 (44.45)	0.86 (21.84)	1.13 (28.70)	0.29 (0.13)
3/8"	DM20003*06	2.00 (50.80)	1.06 (26.92)	1.38 (35.05)	0.56 (0.25)
1/2"	DM20003*08	2.68 (68.07)	1.30 (33.02)	1.50 (38.10)	1.00 (0.45)
3/4"	DM20003*12	3.03 (76.96)	1.58 (40.13)	1.75 (44.45)	1.50 (0.68)
1"	DM20003*16	3.37 (85.60)	1.97 (50.04)	2.00 (50.80)	2.65 (1.20)
1-1/4"	DM20003*20	4.25 (107.95)	2.50 (63.50)	2.38 (60.45)	5.95 (2.70)
1-1/2"	DM20003*24	4.54 (115.32)	2.81 (71.37)	2.50 (63.50)	7.10 (3.22)
2"	DM20003*32	5.45 (138.43)	3.25 (82.55)	3.50 (88.90)	9.60 (4.35)
**3"	DM20003*48	11.09 (281.69)	4.38 (111.25)	5.00 (127.00)	25.23 (11.44)

**3" PYPLOK® DM 20 Series shapes such as Tees and Elbows are made as welded assemblies using ASME B16.9 SCH.160 Butt Weld Fittings. All other sizes are made from forged material.

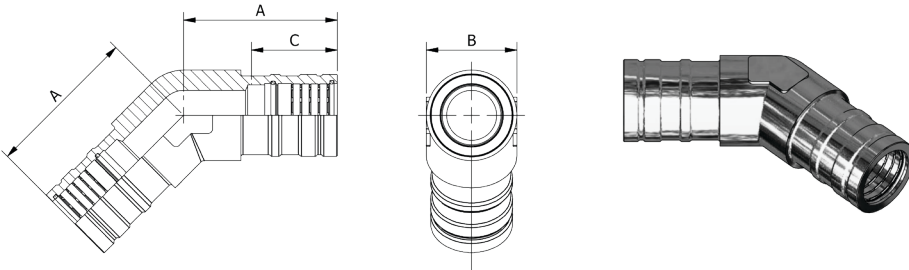

***MATERIAL CODE:**
 K = STAINLESS STEEL
 G = CARBON STEEL
 B = COPPER NICKEL 70/30

ORDER EXAMPLE:
 DM20017G04

45° Elbow, NPS - DM20017

Size NPS	Part Number	Dimensions - Inch (mm)			*Weight K & G lbs (kg)
		A	B	C Insertion Depth	
1/4"	DM20017*04	1.75 (44.45)	0.86 (21.84)	1.13 (28.70)	0.40 (0.18)
3/8"	DM20017*06	2.00 (50.80)	1.06 (26.92)	1.38 (35.05)	0.50 (0.23)
1/2"	DM20017*08	2.68 (68.07)	1.30 (33.02)	1.50 (38.10)	1.00 (0.45)
3/4"	DM20017*12	3.03 (76.96)	1.58 (40.13)	1.75 (44.45)	1.50 (0.68)
1"	DM20017*16	3.37 (85.60)	1.97 (50.04)	2.00 (50.80)	3.10 (1.41)
1-1/4"	DM20017*20	4.25 (107.95)	2.50 (63.50)	2.38 (60.45)	5.60 (2.54)
1-1/2"	DM20017*24	4.54 (115.32)	2.81 (71.37)	2.50 (63.50)	7.40 (3.36)
2"	DM20017*32	5.45 (138.43)	3.25 (82.55)	3.50 (88.90)	9.60 (4.35)
**3"	DM20017*48	8.59 (218.19)	4.38 (111.25)	5.00 (127.00)	21.26 (9.64)

**3" PYPLOK® DM 20 Series shapes such as Tees and Elbows are made as welded assemblies using ASME B16.9 SCH.160 Butt Weld Fittings. All other sizes are made from forged material.

DM 20 Series - NPS Pipe

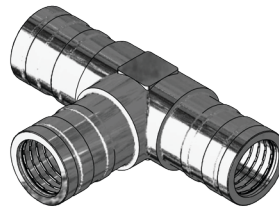
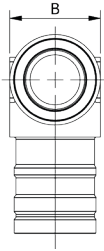
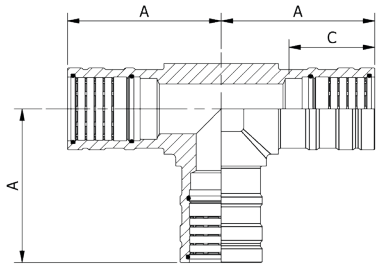

***MATERIAL CODE:**
K = STAINLESS STEEL
G = CARBON STEEL
B = COPPER NICKEL 70/30

ORDER EXAMPLE:
DM20004G04

Tee, NPS - DM20004

Size NPS	Part Number	Dimensions - Inch (mm)			*Weight K & G lbs (kg)
		A	B	C Insertion Depth	
1/4"	DM20004*04	1.75 (44.45)	0.86 (21.84)	1.13 (28.70)	0.38 (0.17)
3/8"	DM20004*06	2.00 (50.80)	1.06 (26.92)	1.38 (35.05)	0.65 (0.29)
1/2"	DM20004*08	2.68 (68.07)	1.30 (33.02)	1.50 (38.10)	1.30 (0.59)
3/4"	DM20004*12	3.03 (76.96)	1.58 (40.13)	1.75 (44.45)	2.00 (0.91)
1"	DM20004*16	3.37 (85.60)	1.97 (50.04)	2.00 (50.80)	3.40 (1.54)
1-1/4"	DM20004*20	4.25 (107.95)	2.50 (63.50)	2.38 (60.45)	7.10 (3.22)
1-1/2"	DM20004*24	4.54 (115.32)	2.81 (71.37)	2.50 (63.50)	9.20 (4.17)
2"	DM20004*32	5.45 (138.43)	3.25 (82.55)	3.50 (88.90)	12.80 (5.81)
**3"	DM20004*48	9.97 (253.24)	4.38 (111.25)	5.00 (127.00)	34.95 (15.85)

**3" PYPLOK® DM 20 Series shapes such as Tees and Elbows are made as welded assemblies using ASME B16.9 SCH.160 Butt Weld Fittings. All other sizes are made from forged material.

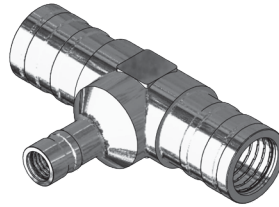
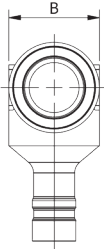
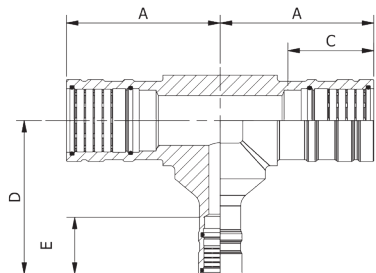

***MATERIAL CODE:**
K = STAINLESS STEEL
G = CARBON STEEL
B = COPPER NICKEL 70/30

ORDER EXAMPLE:
DM20104G0604

Other configurations available.
 Contact factory for details.

Reducing Tee, NPS - DM20104

Run Size NPS	Branch Size NPS	Part Number	Dimensions - Inch (mm)					*Weight K & G lbs (kg)
			A	B	C Insertion Depth	D	E Insertion Depth	
3/8"	1/4"	DM20104*0604	2.00 (50.80)	1.06 (26.92)	1.38 (35.05)	2.00 (50.80)	1.13 (28.70)	0.62 (0.28)
1/2"	3/8"	DM20104*0806	2.68 (68.07)	1.30 (33.02)	1.50 (38.10)	2.50 (63.50)	1.38 (35.05)	1.30 (0.59)
3/4"	1/2"	DM20104*1208	3.03 (76.96)	1.58 (40.13)	1.75 (44.45)	3.13 (79.50)	1.50 (38.10)	2.00 (0.91)
1"	1/2"	DM20104*1608	3.37 (85.60)	1.97 (50.04)	2.00 (50.80)	3.27 (83.06)	1.50 (38.10)	3.20 (1.45)
1"	3/4"	DM20104*1612	3.37 (85.60)	1.97 (50.04)	2.00 (50.80)	3.37 (85.60)	1.75 (44.45)	3.20 (1.45)
1 1/4"	1/2"	DM20104*2008	4.25 (107.95)	2.50 (63.50)	2.38 (60.45)	4.25 (107.95)	1.50 (38.10)	6.80 (3.08)
1-1/4"	3/4"	DM20104*2012	4.25 (107.95)	2.50 (63.50)	2.38 (60.45)	4.25 (107.95)	1.75 (44.45)	6.80 (3.08)
1-1/4"	1"	DM20104*2016	4.25 (107.95)	2.50 (63.50)	2.38 (60.45)	4.25 (107.95)	2.00 (50.80)	6.80 (3.08)
1 1/2"	3/4"	DM20104*2412	4.54 (115.32)	2.81 (71.37)	2.50 (63.50)	4.54 (115.32)	1.75 (44.45)	8.80 (3.99)
1-1/2"	1"	DM20104*2416	4.54 (115.32)	2.81 (71.37)	2.50 (63.50)	4.54 (115.32)	2.00 (50.80)	8.80 (3.99)
1-1/2"	1-1/4"	DM20104*2420	4.54 (115.32)	2.81 (71.37)	2.50 (63.50)	4.54 (115.32)	2.38 (60.45)	8.80 (3.99)
2"	1"	DM20104*3216	5.45 (138.43)	3.25 (82.55)	3.50 (88.90)	5.38 (136.65)	2.00 (50.80)	12.40 (5.62)
2"	1-1/4"	DM20104*3220	5.45 (138.43)	3.25 (82.55)	3.50 (88.90)	5.38 (136.65)	2.38 (60.45)	13.10 (5.94)
2"	1-1/2"	DM20104*3224	5.45 (138.43)	3.25 (82.55)	3.50 (88.90)	5.38 (136.65)	2.50 (63.50)	13.40 (6.08)

3D step models available upon request

DM 20 Series - NPS Pipe

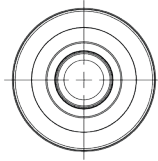
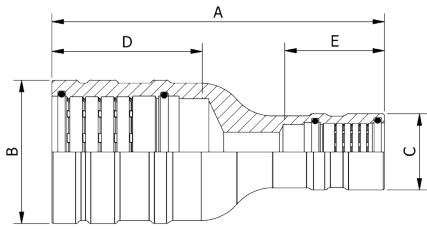

*MATERIAL CODE:
 K = STAINLESS STEEL
 G = CARBON STEEL
 B = COPPER NICKEL 70/30

ORDER EXAMPLE:
 DM20101G0604

Other configurations available.
 Contact factory for details.

Reducer, NPS - DM20101

End 1 Size NPS	End 2 Size NPS	Part Number	Dimensions - Inch (mm)					*Weight K & G lbs (kg)
			A	B	C	D Insertion Depth	E Insertion Depth	
3/8"	1/4"	DM20101*0604	3.00 (76.20)	0.99 (25.15)	0.80 (20.32)	1.38 (35.05)	1.13 (28.70)	0.26 (0.12)
1/2"	3/8"	DM20101*0806	3.75 (95.25)	1.20 (30.48)	0.99 (25.15)	1.50 (38.10)	1.38 (35.05)	0.40 (0.18)
3/4"	1/2"	DM20101*1208	4.38 (111.25)	1.48 (37.59)	1.20 (30.48)	1.75 (44.45)	1.50 (38.10)	0.70 (0.32)
1"	1/2"	DM20101*1608	5.00 (127.00)	1.82 (46.23)	1.20 (30.48)	2.00 (50.80)	1.50 (38.10)	1.25 (0.57)
1"	3/4"	DM20101*1612	5.00 (127.00)	1.82 (46.23)	1.48 (37.59)	2.00 (50.80)	1.75 (44.45)	1.30 (0.59)
1-1/4"	3/4"	DM20101*2012	5.38 (136.65)	2.26 (57.40)	1.48 (37.59)	2.38 (60.45)	1.75 (44.45)	1.80 (0.82)
1-1/4"	1"	DM20101*2016	5.38 (136.65)	2.26 (57.40)	1.82 (46.23)	2.38 (60.45)	2.00 (50.80)	2.04 (0.93)
1-1/2"	3/4"	DM20101*2412	5.88 (149.35)	2.58 (65.53)	1.48 (37.59)	2.50 (63.50)	1.75 (44.45)	2.82 (1.28)
1-1/2"	1"	DM20101*2416	5.88 (149.35)	2.58 (65.53)	1.82 (46.23)	2.50 (63.50)	2.00 (50.80)	2.85 (1.29)
1-1/2"	1-1/4"	DM20101*2420	6.00 (154.43)	2.58 (65.53)	2.26 (57.40)	2.50 (63.50)	2.38 (60.45)	3.17 (1.44)
2"	1"	DM20101*3216	7.00 (177.80)	3.04 (77.22)	1.82 (46.23)	3.50 (88.90)	2.00 (50.80)	3.69 (1.67)
2"	1-1/4"	DM20101*3220	7.25 (184.15)	3.04 (77.22)	2.26 (57.40)	3.50 (88.90)	2.38 (60.45)	4.20 (1.90)
2"	1-1/2"	DM20101*3224	7.50 (190.05)	3.04 (77.22)	2.58 (65.53)	3.50 (88.90)	2.50 (63.50)	4.67 (2.12)

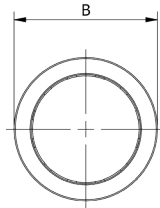
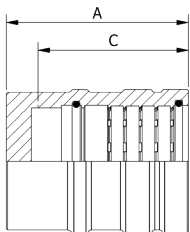

*MATERIAL CODE:
 K = STAINLESS STEEL
 G = CARBON STEEL
 B = COPPER NICKEL 70/30

ORDER EXAMPLE:
 DM20085G04

End Cap, NPS - DM20085

Size NPS	Part Number	Dimensions - Inch (mm)			*Weight K & G lbs (kg)
		A	B	C Insertion Depth	
1/4"	DM20085*04	1.38 (35.05)	0.80 (20.32)	1.13 (28.70)	0.10 (0.05)
3/8"	DM20085*06	1.88 (47.75)	0.99 (25.15)	1.38 (35.05)	0.20 (0.09)
1/2"	DM20085*08	2.00 (50.80)	1.20 (30.48)	1.50 (38.10)	0.30 (0.14)
3/4"	DM20085*12	2.25 (57.15)	1.48 (37.59)	1.75 (44.45)	0.50 (0.23)
1"	DM20085*16	2.50 (63.50)	1.82 (46.23)	2.00 (50.80)	0.84 (0.38)
1-1/4"	DM20085*20	2.88 (73.15)	2.26 (57.40)	2.38 (60.45)	1.44 (0.65)
1-1/2"	DM20085*24	3.00 (76.20)	2.58 (65.53)	2.50 (63.50)	1.98 (0.90)
2"	DM20085*32	4.13 (104.90)	3.04 (77.22)	3.50 (88.90)	3.13 (1.42)
3"	DM20085*48	5.63 (143.00)	4.38 (111.25)	5.00 (127.00)	8.56 (3.88)

3D step models available upon request

DM 20 Series - NPS Pipe

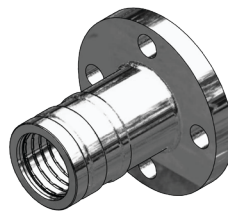
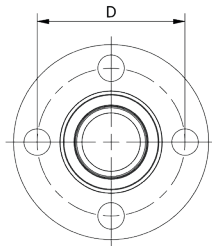
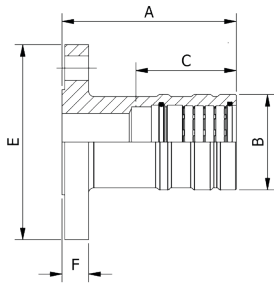

***MATERIAL CODE:**
 K = STAINLESS STEEL
 G = CARBON STEEL
 B = COPPER NICKEL 70/30

ORDER EXAMPLE:
 DM20018G08

Flange – ANSI 150#, NPS - DM20018

Size NPS	Flange Size	Part Number	Dimensions - Inch (mm)						Bolt Size	*Weight K & G lbs (kg)
			A	B	C Insertion Depth	D	E	F		
1/2"	1/2"	DM20018*08	3.00 (76.20)	1.20 (30.48)	1.50 (38.10)	2.38 (60.45)	3.50 (88.90)	0.44 (11.18)	1/2" UNC	1.30 (0.59)
3/4"	3/4"	DM20018*12	3.50 (88.90)	1.48 (37.59)	1.75 (44.45)	2.75 (69.85)	3.88 (98.55)	0.50 (12.70)	1/2" UNC	1.90 (0.86)
1"	1"	DM20018*16	3.63 (92.20)	1.82 (46.23)	2.00 (50.80)	3.12 (79.25)	4.25 (107.95)	0.62 (15.82)	1/2" UNC	3.00 (1.36)
1-1/4"	1-1/4"	DM20018*20	4.13 (104.90)	2.26 (57.40)	2.38 (60.45)	3.50 (88.90)	4.62 (117.35)	0.63 (16.00)	1/2" UNC	4.09 (1.86)
1-1/2"	1-1/2"	DM20018*24	4.25 (107.95)	2.58 (65.53)	2.50 (63.50)	3.88 (98.55)	5.00 (127.00)	0.75 (19.10)	1/2" UNC	5.20 (2.40)
2"	2"	DM20018*32	5.73 (145.54)	3.04 (77.22)	3.50 (88.90)	4.75 (120.65)	6.00 (152.40)	0.69 (17.53)	5/8" UNC	8.50 (3.86)
**3"	3"	DM20018*48	9.34 (237.24)	4.38 (111.25)	5.00 (127.00)	6.00 (152.40)	7.50 (190.50)	1.31 (33.27)	5/8" UNC	24.83 (11.26)

**3" PYPLOK® DM 20 Series shapes such as Tees and Elbows are made as welded assemblies using ASME B16.9 SCH.160 Butt Weld Fittings. All other sizes are made from forged material.

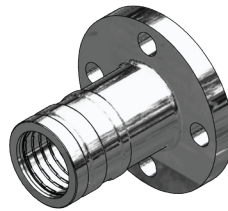
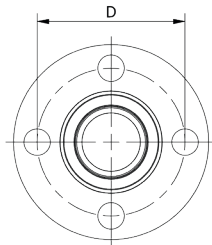
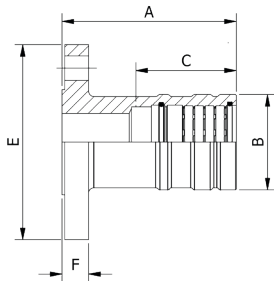

***MATERIAL CODE:**
 K = STAINLESS STEEL
 G = CARBON STEEL
 B = COPPER NICKEL 70/30

ORDER EXAMPLE:
 DM20019G08

Flange – ANSI 300#, NPS - DM20019

Size NPS	Flange Size	Part Number	Dimensions - Inch (mm)						Bolt Size	*Weight K & G lbs (kg)
			A	B	C Insertion Depth	D	E	F		
1/2"	1/2"	DM20019*08	3.13 (79.50)	1.20 (30.48)	1.50 (38.10)	2.62 (66.55)	3.75 (95.25)	0.56 (14.22)	1/2" UNC	1.84 (0.83)
3/4"	3/4"	DM20019*12	3.63 (92.20)	1.48 (37.59)	1.75 (44.45)	3.25 (82.55)	4.63 (117.60)	0.63 (16.00)	5/8" UNC	3.10 (1.41)
1"	1"	DM20019*16	3.88 (98.55)	1.82 (46.23)	2.00 (50.80)	3.50 (88.90)	4.88 (123.95)	0.75 (19.05)	5/8" UNC	4.34 (1.97)
1-1/4"	1-1/4"	DM20019*20	4.25 (107.95)	2.26 (57.40)	2.38 (60.45)	3.88 (98.55)	5.25 (133.35)	0.75 (19.05)	5/8" UNC	5.40 (2.45)
1-1/2"	1-1/2"	DM20019*24	4.31 (109.47)	2.58 (65.53)	2.50 (63.50)	4.50 (114.30)	6.12 (155.45)	0.81 (20.57)	3/4" UNC	9.70 (4.40)
**2"	2"	DM20019*32	5.80 (147.32)	3.04 (77.72)	3.50 (88.90)	5.00 (127.00)	6.50 (165.10)	0.88 (22.35)	5/8" UNC	9.77 (4.43)
**3"	3"	DM20019*48	9.72 (246.89)	4.38 (111.25)	5.00 (127.00)	6.63 (168.40)	8.25 (209.55)	1.13 (28.70)	3/4" UNC	26.15 (11.86)

**2" ANSI 300# Flange has 8 Bolts.

**3" PYPLOK® DM 20 Series shapes such as Tees and Elbows are made as welded assemblies using ASME B16.9 SCH.160 Butt Weld Fittings. All other sizes are made from forged material.

3D step models available upon request

DM 20 Series - NPS Pipe

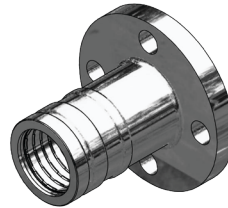
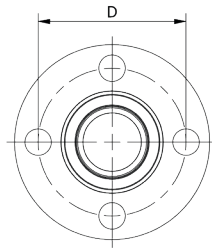
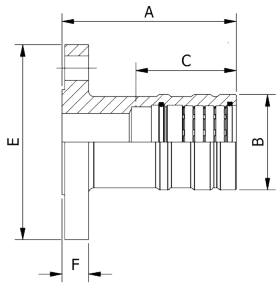

***MATERIAL CODE:**
 K = STAINLESS STEEL
 G = CARBON STEEL
 B = COPPER NICKEL 70/30

ORDER EXAMPLE:
 DM20027G08

Flange – ANSI 600#, NPS - DM20027

Size NPS	Flange Size	Part Number	Dimensions - Inch (mm)						Bolt Size	*Weight K & G lbs (kg)
			A	B	C Insertion Depth	D	E	F		
1/2"	1/2"	DM20027*08	3.31 (84.07)	1.20 (30.48)	1.50 (38.10)	2.63 (66.80)	3.75 (95.25)	0.81 (20.57)	1/2 UNC	2.07 (0.94)
3/4"	3/4"	DM20027*12	3.81 (96.77)	1.48 (37.59)	1.75 (44.45)	3.25 (82.55)	4.63 (117.60)	0.88 (22.35)	5/8 UNC	3.53 (1.60)
1"	1"	DM20027*16	4.00 (101.60)	1.82 (46.23)	2.00 (50.80)	3.50 (88.90)	4.88 (123.95)	0.94 (23.88)	5/8 UNC	4.51 (2.05)
1-1/4"	1-1/4"	DM20027*20	4.50 (114.30)	2.26 (57.40)	2.38 (60.45)	3.88 (98.55)	5.25 (133.35)	1.06 (26.92)	5/8 UNC	6.48 (2.94)
1-1/2"	1-1/2"	DM20027*24	4.63 (117.60)	2.58 (65.53)	2.50 (63.50)	4.50 (114.30)	6.13 (155.70)	1.13 (28.70)	3/4 UNC	9.13 (4.14)
2"	2"	DM20027*32	5.73 (145.54)	3.04 (77.22)	3.50 (88.90)	5.00 (127.00)	6.50 (165.10)	1.25 (31.75)	5/8 UNC	10.92 (4.95)
**3"	3"	DM20027*48	9.97 (253.24)	4.38 (111.25)	5.00 (127.00)	6.63 (168.40)	8.13 (206.50)	1.38 (35.05)	3/4 UNC	25.76 (11.68)

**3" PYPLOK® DM 20 Series shapes such as Tees and Elbows are made as welded assemblies using ASME B16.9 SCH.160 Butt Weld Fittings. All other sizes are made from forged material.

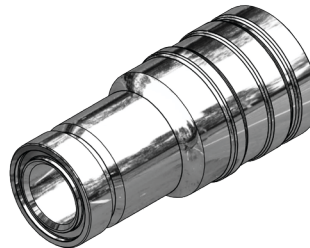
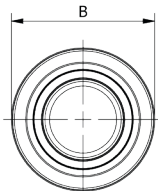
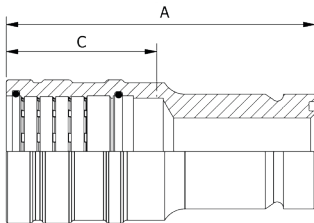

***MATERIAL CODE:**
 K = STAINLESS STEEL
 G = CARBON STEEL
 B = COPPER NICKEL 70/30

ORDER EXAMPLE:
 DM20090G08

SAE Flange Body, NPS - DM20090

Size NPS	Flange Size	Part Number	Dimensions - Inch (mm)			*Weight K & G lbs (kg)
			A	B	C Insertion Depth	
1/2"	1/2"	DM20090*08	3.38 (85.85)	1.20 (30.48)	1.50 (38.10)	0.51 (0.23)
3/4"	3/4"	DM20090*12	3.50 (88.90)	1.48 (37.59)	1.75 (44.45)	0.87 (0.39)
1"	1"	DM20090*16	4.50 (114.30)	1.82 (46.23)	2.00 (50.80)	1.49 (0.68)
1-1/4"	1-1/4"	DM20090*20	4.88 (123.95)	2.26 (57.40)	2.38 (60.45)	2.13 (0.97)
1-1/2"	1-1/2"	DM20090*24	5.00 (127.00)	2.58 (65.53)	2.50 (63.50)	3.00 (1.36)
2"	2"	DM20090*32	6.50 (165.10)	3.04 (77.22)	3.50 (88.90)	4.43 (2.01)
3"	3"	DM20090*48	9.50 (241.30)	4.38 (111.25)	5.00 (127.00)	13.41 (6.08)

DM 20 Series - NPS Pipe

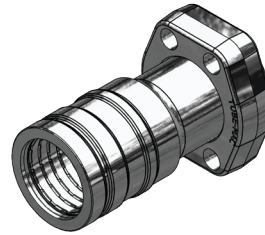
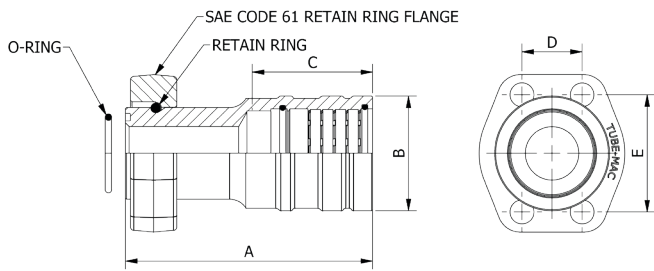

***MATERIAL CODE:**
 K = STAINLESS STEEL
 G = CARBON STEEL
 B = COPPER NICKEL 70/30

ORDER EXAMPLE:
 DM20091G08

SAE Code 61 Flange, NPS - DM20091

Size NPS	Flange Size	Part Number	Dimensions - Inch (mm)					Bolt Minimum Grade 8	*Weight K & G lbs (kg)
			A	B	C Insertion Depth	D	E		
1/2"	1/2"	DM20091*08	3.38 (85.85)	1.20 (30.48)	1.50 (38.10)	0.69 (17.53)	1.50 (38.10)	5/16" UNC	0.97 (0.44)
3/4"	3/4"	DM20091*12	3.50 (88.90)	1.48 (37.59)	1.75 (44.45)	0.88 (22.35)	1.88 (47.75)	3/8" UNC	1.35 (0.61)
1"	1"	DM20091*16	4.50 (114.30)	1.82 (46.23)	2.00 (50.80)	1.03 (26.16)	2.06 (52.32)	3/8" UNC	2.12 (0.96)
1-1/4"	1-1/4"	DM20091*20	4.88 (123.95)	2.26 (57.40)	2.38 (60.45)	1.19 (30.23)	2.31 (58.67)	7/16" UNC	3.03 (1.37)
1-1/2"	1-1/2"	DM20091*24	5.00 (127.00)	2.58 (65.53)	2.50 (63.50)	1.41 (35.81)	2.75 (69.85)	1/2" UNC	4.35 (1.97)
2"	2"	DM20091*32	6.50 (165.10)	3.04 (77.22)	3.50 (88.90)	1.69 (42.93)	3.06 (77.72)	1/2" UNC	6.45 (2.93)
3"	3"	DM20091*48	9.50 (241.30)	4.38 (111.25)	5.00 (127.00)	2.44 (61.98)	4.19 (106.43)	5/8" UNC	17.51 (7.90)

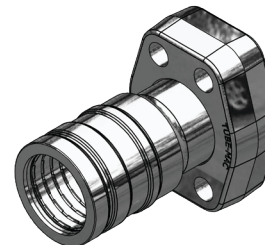
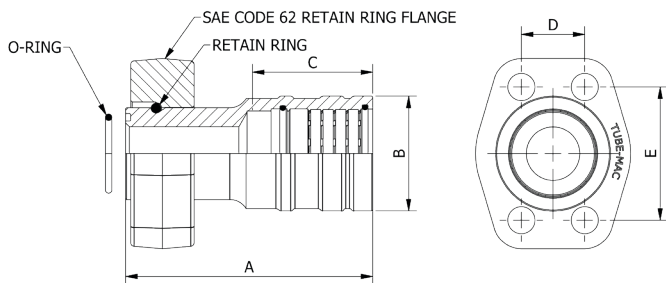

***MATERIAL CODE:**
 K = STAINLESS STEEL
 G = CARBON STEEL
 B = COPPER NICKEL 70/30

ORDER EXAMPLE:
 DM20092G08

SAE Code 62 Flange, NPS - DM20092

Size NPS	Flange Size	Part Number	Dimensions - Inch (mm)					Bolt Minimum Grade 8	*Weight K & G lbs (kg)
			A	B	C Insertion Depth	D	E		
1/2"	1/2"	DM20092*08	3.38 (85.85)	1.20 (30.48)	1.50 (38.10)	0.72 (18.29)	1.59 (40.39)	5/16" UNC	0.97 (0.44)
3/4"	3/4"	DM20092*12	3.50 (88.90)	1.48 (37.59)	1.75 (44.45)	0.94 (23.88)	2.00 (50.80)	3/8" UNC	1.68 (0.76)
1"	1"	DM20092*16	4.50 (114.30)	1.82 (46.23)	2.00 (50.80)	1.09 (27.69)	2.25 (57.15)	7/16" UNC	2.75 (1.25)
1-1/4"	1-1/4"	DM20092*20	4.88 (123.95)	2.26 (57.40)	2.38 (60.45)	1.25 (31.75)	2.63 (66.80)	1/2" UNC	4.08 (1.85)
1-1/2"	1-1/2"	DM20092*24	5.00 (127.00)	2.58 (65.53)	2.50 (63.50)	1.44 (36.58)	3.13 (79.50)	5/8" UNC	5.88 (2.67)
2"	2"	DM20092*32	6.50 (165.10)	3.04 (77.22)	3.50 (88.90)	1.75 (44.45)	3.81 (96.77)	3/4" UNC	9.83 (4.46)
**3"	3"	DM20092*48	9.50 (241.30)	4.38 (111.25)	5.00 (127.00)	2.44 (61.98)	4.19 (106.43)	5/8" UNC	22.51 (10.21)

**3" uses ISO 6164 Flange.

3D step models available upon request

DM 20 Series - NPS Pipe

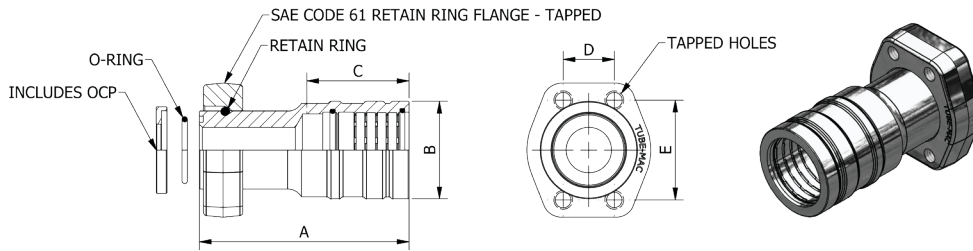

*MATERIAL CODE:
 K = STAINLESS STEEL
 G = CARBON STEEL
 B = COPPER NICKEL 70/30

ORDER EXAMPLE:
 DM20095G08

SAE Code 61 Tapped Flange, NPS - DM20095

Size NPS	Flange Size	Part Number	Dimensions - Inch (mm)					Tap UNC-2B	*Weight K & G lbs (kg)
			A	B	C Insertion Depth	D	E		
1/2"	1/2"	DM20095*08	3.38 (85.85)	1.20 (30.48)	1.50 (38.10)	0.69 (17.53)	1.50 (38.10)	5/16"-18	1.01 (0.46)
3/4"	3/4"	DM20095*12	3.50 (88.90)	1.48 (37.59)	1.75 (44.45)	0.88 (22.35)	1.88 (47.75)	3/8"-16	1.42 (0.64)
1"	1"	DM20095*16	4.50 (114.30)	1.82 (46.23)	2.00 (50.80)	1.03 (26.16)	2.06 (52.32)	3/8"-16	2.20 (1.00)
1-1/4"	1-1/4"	DM20095*20	4.88 (123.95)	2.26 (57.40)	2.38 (60.45)	1.19 (30.23)	2.31 (58.67)	7/16"-14	3.12 (1.42)
1-1/2"	1-1/2"	DM20095*24	5.00 (127.00)	2.58 (65.53)	2.50 (63.50)	1.41 (35.81)	2.75 (69.85)	1/2"-13	4.52 (2.05)
2"	2"	DM20095*32	6.50 (165.10)	3.04 (77.22)	3.50 (88.90)	1.69 (42.93)	3.06 (77.72)	1/2"-13	6.60 (2.99)
3"	3"	DM20095*48	9.50 (241.30)	4.38 (111.25)	5.00 (127.00)	2.44 (61.98)	4.19 (106.43)	5/8"-11	17.51 (7.90)

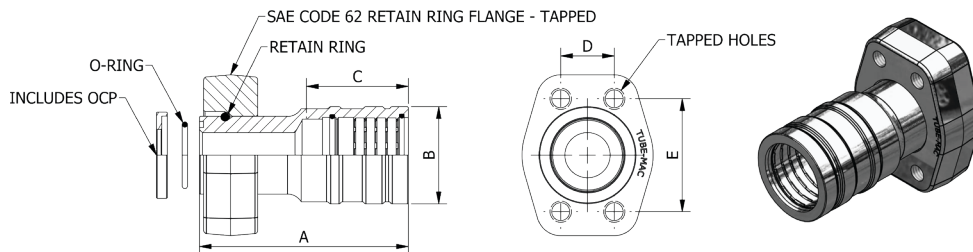

*MATERIAL CODE:
 K = STAINLESS STEEL
 G = CARBON STEEL
 B = COPPER NICKEL 70/30

ORDER EXAMPLE:
 DM20096G08

SAE Code 62 Tapped Flange, NPS - DM20096

Size NPS	Flange Size	Part Number	Dimensions - Inch (mm)					Tap UNC-2B	*Weight K & G lbs (kg)
			A	B	C Insertion Depth	D	E		
1/2"	1/2"	DM20096*08	3.38 (85.85)	1.20 (30.48)	1.50 (38.10)	0.72 (18.29)	1.59 (40.39)	5/16"-18	1.01 (0.46)
3/4"	3/4"	DM20096*12	3.50 (88.90)	1.48 (37.59)	1.75 (44.45)	0.94 (23.88)	2.00 (50.80)	3/8"-16	1.84 (0.83)
1"	1"	DM20096*16	4.50 (114.30)	1.82 (46.23)	2.00 (50.80)	1.09 (27.69)	2.25 (57.15)	7/16"-14	2.83 (1.28)
1-1/4"	1-1/4"	DM20096*20	4.88 (123.95)	2.26 (57.40)	2.38 (60.45)	1.25 (31.75)	2.63 (66.80)	1/2"-13	4.42 (2.00)
1-1/2"	1-1/2"	DM20096*24	5.00 (127.00)	2.58 (65.53)	2.50 (63.50)	1.44 (36.58)	3.13 (79.50)	5/8"-11	6.47 (2.93)
2"	2"	DM20096*32	6.50 (165.10)	3.04 (77.22)	3.50 (88.90)	1.75 (44.45)	3.81 (96.77)	3/4"-10	10.17 (4.61)
**3"	3"	DM20096*48	9.50 (241.30)	4.38 (111.25)	5.00 (127.00)	2.44 (61.89)	4.19 (106.43)	1"-8	22.51 (10.21)

**3" uses ISO 6164 Flange.

DM 20 Series - NPS Pipe

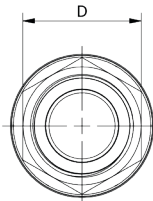
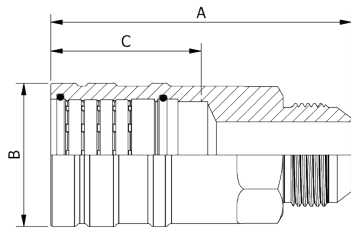

*MATERIAL CODE:
 K = STAINLESS STEEL
 G = CARBON STEEL
 B = COPPER NICKEL 70/30

ORDER EXAMPLE:
 DM20055G04

JIC 37° Male, NPS - DM20055

Size NPS	JIC Size	Part Number	Dimensions - Inch (mm)				*Weight K & G lbs (kg)
			A	B	C Insertion Depth	D	
1/4"	04	DM20055*04	2.25 (57.15)	0.80 (20.32)	1.13 (28.70)	0.50 (12.70)	0.10 (0.05)
3/8"	06	DM20055*06	2.63 (66.80)	0.99 (25.15)	1.38 (35.05)	0.63 (16.00)	0.21 (0.10)
1/2"	08	DM20055*08	3.25 (82.55)	1.20 (30.48)	1.50 (38.10)	0.81 (20.57)	0.37 (0.17)
3/4"	12	DM20055*12	3.69 (93.73)	1.48 (37.59)	1.75 (44.45)	1.13 (28.70)	0.63 (0.29)
1"	16	DM20055*16	4.00 (101.60)	1.82 (46.23)	2.00 (50.80)	1.38 (35.05)	1.06 (0.48)
1-1/4"	20	DM20055*20	4.75 (120.65)	2.26 (57.40)	2.38 (60.45)	1.88 (47.75)	2.11 (0.96)
1-1/2"	24	DM20055*24	4.75 (120.65)	2.58 (65.53)	2.50 (63.50)	2.25 (57.15)	2.66 (1.21)
2"	32	DM20055*32	6.00 (152.40)	3.04 (77.22)	3.50 (88.90)	2.63 (66.80)	4.08 (1.85)

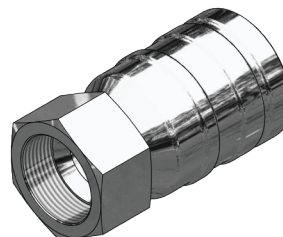
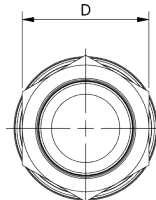
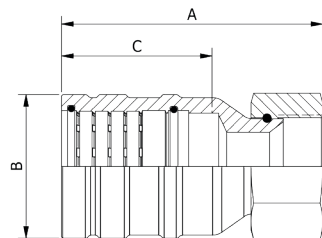

*MATERIAL CODE:
 K = STAINLESS STEEL
 G = CARBON STEEL
 B = COPPER NICKEL 70/30

ORDER EXAMPLE:
 DM20054G04

JIC 37° Female Swivel, NPS - DM20054

Size NPS	JIC Size	Part Number	Dimensions - Inch (mm)				*Weight K & G lbs (kg)
			A	B	C Insertion Depth	D	
1/4"	04	DM20054*04	2.23 (56.64)	0.80 (20.32)	1.13 (28.70)	0.56 (14.22)	0.12 (0.05)
3/8"	06	DM20054*06	2.67 (67.82)	0.99 (25.15)	1.38 (35.05)	0.69 (17.53)	0.21 (0.10)
1/2"	08	DM20054*08	3.07 (77.98)	1.20 (30.48)	1.50 (38.10)	0.88 (22.35)	0.37 (0.17)
3/4"	12	DM20054*12	3.40 (86.36)	1.48 (37.59)	1.75 (44.45)	1.25 (31.75)	0.74 (0.34)
1"	16	DM20054*16	4.05 (102.87)	1.82 (46.23)	2.00 (50.80)	1.50 (38.10)	1.19 (0.54)
1-1/4"	20	DM20054*20	4.40 (111.76)	2.26 (57.40)	2.38 (60.45)	2.00 (50.80)	2.15 (0.98)
1-1/2"	24	DM20054*24	4.77 (121.16)	2.58 (65.53)	2.50 (63.50)	2.25 (57.15)	3.00 (1.36)
2"	32	DM20054*32	5.99 (152.15)	3.04 (77.22)	3.50 (88.90)	2.88 (73.15)	4.53 (2.05)

3D step models available upon request

DM 20 Series - NPS Pipe

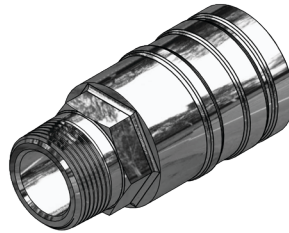
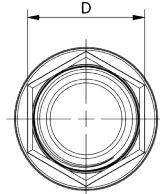
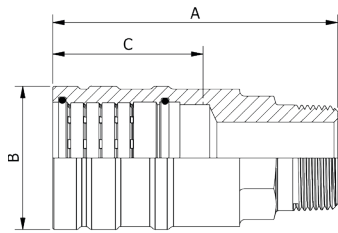

*MATERIAL CODE:
 K = STAINLESS STEEL
 G = CARBON STEEL
 B = COPPER NICKEL 70/30

ORDER EXAMPLE:
 DM20056G04

NPT Male, NPS - DM20056

Size NPS	NPT Size	Part Number	Dimensions - Inch (mm)				*Weight K & G lbs (kg)
			A	B	C Insertion Depth	D	
1/4"	1/4"	DM20056*04	2.25 (57.15)	0.80 (20.32)	1.13 (28.70)	0.56 (14.22)	0.12 (0.05)
3/8"	3/8"	DM20056*06	2.63 (66.80)	0.99 (25.15)	1.38 (35.05)	0.75 (19.05)	0.21 (0.10)
1/2"	1/2"	DM20056*08	3.25 (82.55)	1.20 (30.48)	1.50 (38.10)	0.88 (22.35)	0.40 (0.18)
3/4"	3/4"	DM20056*12	3.50 (88.90)	1.48 (37.59)	1.75 (44.45)	1.25 (31.75)	0.76 (0.34)
1"	1"	DM20056*16	4.00 (101.6)	1.82 (46.23)	2.00 (50.80)	1.50 (38.10)	1.20 (0.54)
1-1/4"	1-1/4"	DM20056*20	4.50 (63.50)	2.26 (57.40)	2.38 (60.45)	2.39 (60.71)	2.07 (0.94)
1-1/2"	1-1/2"	DM20056*24	4.75 (120.65)	2.58 (65.53)	2.50 (63.50)	2.13 (54.10)	2.50 (1.13)
2"	2"	DM20056*32	6.00 (152.40)	3.04 (77.22)	3.50 (88.90)	2.63 (66.80)	4.41 (2.00)

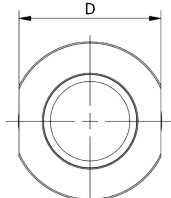
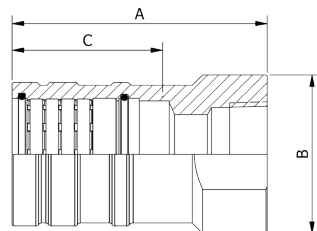

*MATERIAL CODE:
 K = STAINLESS STEEL
 G = CARBON STEEL
 B = COPPER NICKEL 70/30

ORDER EXAMPLE:
 DM20060G04

NPT Female, NPS - DM20060

Size NPS	NPT Size	Part Number	Dimensions - Inch (mm)				*Weight K & G lbs (kg)
			A	B	C Insertion Depth	D	
1/4"	1/4"	DM20060*04	2.00 (50.80)	1.00 (25.40)	1.13 (28.70)	0.88 (22.35)	0.20 (0.09)
3/8"	3/8"	DM20060*06	2.25 (57.15)	1.25 (31.75)	1.38 (35.05)	1.00 (25.40)	0.32 (0.15)
1/2"	1/2"	DM20060*08	2.75 (69.85)	1.38 (35.05)	1.50 (38.10)	1.25 (31.75)	0.48 (0.22)
3/4"	3/4"	DM20060*12	3.25 (82.55)	1.75 (44.45)	1.75 (44.45)	1.50 (38.10)	0.90 (0.41)
1"	1"	DM20060*16	3.63 (92.20)	1.98 (50.29)	2.00 (50.80)	1.88 (47.75)	1.40 (0.63)
1-1/4"	1-1/4"	DM20060*20	4.03 (102.36)	2.50 (63.50)	2.38 (60.45)	2.25 (57.15)	2.20 (1.00)
1-1/2"	1-1/2"	DM20060*24	4.38 (111.25)	3.00 (76.20)	2.50 (63.50)	2.74 (69.60)	3.53 (1.60)
2"	2"	DM20060*32	5.50 (139.70)	3.50 (88.90)	3.50 (88.90)	3.00 (76.20)	4.80 (2.17)

DM 20 Series - NPS Pipe

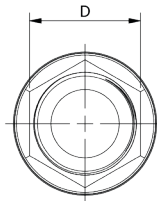
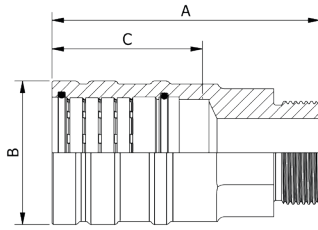

*MATERIAL CODE:
 K = STAINLESS STEEL
 G = CARBON STEEL
 B = COPPER NICKEL 70/30

ORDER EXAMPLE:
 DM20088G04

SAE Male, NPS - DM20088

Size NPS	SAE Size	Part Number	Dimensions - Inch (mm)				*Weight K & G lbs (kg)
			A	B	C Insertion Depth	D	
1/4"	04	DM20088*04	2.18 (55.37)	0.80 (20.32)	1.13 (28.70)	0.50 (12.70)	0.12 (0.05)
3/8"	06	DM20088*06	2.47 (62.74)	0.99 (25.15)	1.38 (35.05)	0.69 (17.53)	0.20 (0.09)
1/2"	08	DM20088*08	2.74 (69.60)	1.20 (30.48)	1.50 (38.10)	0.88 (22.35)	0.33 (0.15)
3/4"	12	DM20088*12	3.35 (85.09)	1.48 (37.59)	1.75 (44.45)	1.13 (28.70)	0.61 (0.28)
1"	16	DM20088*16	3.73 (94.74)	1.82 (46.23)	2.00 (50.80)	1.50 (38.10)	1.09 (0.49)
1-1/4"	20	DM20088*20	4.23 (107.44)	2.26 (57.40)	2.38 (60.45)	1.88 (47.75)	1.87 (0.85)
1-1/2"	24	DM20088*24	4.48 (113.79)	2.58 (65.53)	2.50 (63.50)	2.13 (54.10)	2.56 (1.16)
2"	32	DM20088*32	5.35 (135.89)	3.04 (77.22)	3.50 (88.90)	2.75 (69.85)	3.84 (1.74)

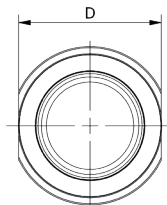
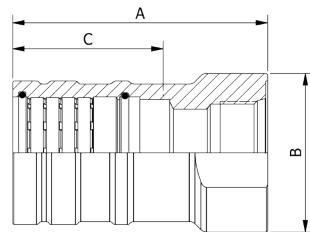

*MATERIAL CODE:
 K = STAINLESS STEEL
 G = CARBON STEEL
 B = COPPER NICKEL 70/30

ORDER EXAMPLE:
 DM20087G04

SAE Female, NPS - DM20087

Size NPS	SAE Size	Part Number	Dimensions - Inch (mm)				*Weight K & G lbs (kg)
			A	B	C Insertion Depth	D	
1/4"	04	DM20087*04	2.00 (50.80)	0.88 (22.35)	1.13 (28.70)	0.75 (19.05)	0.16 (0.07)
3/8"	06	DM20087*06	2.38 (60.45)	1.00 (25.40)	1.38 (35.05)	0.88 (22.35)	0.26 (0.12)
1/2"	08	DM20087*08	2.63 (66.80)	1.25 (31.75)	1.50 (38.10)	1.13 (28.70)	0.42 (0.19)
3/4"	12	DM20087*12	3.25 (82.55)	1.75 (44.45)	1.75 (44.45)	1.50 (38.10)	0.90 (0.41)
1"	16	DM20087*16	3.60 (91.44)	1.98 (50.29)	2.00 (50.80)	1.75 (44.45)	1.27 (0.58)
1-1/4"	20	DM20087*20	4.03 (102.36)	2.50 (63.50)	2.38 (60.45)	2.25 (57.15)	1.96 (0.89)
1-1/2"	24	DM20087*24	4.35 (110.49)	2.75 (69.85)	2.50 (63.50)	2.50 (63.50)	2.80 (1.27)
2"	32	DM20087*32	5.75 (146.05)	3.50 (88.90)	3.50 (88.90)	3.25 (82.55)	5.09 (2.31)

3D step models available upon request

DM 20 Series - NPS Pipe

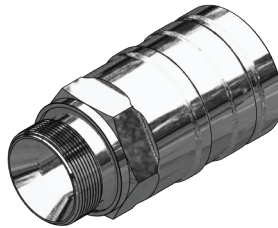
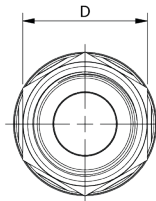
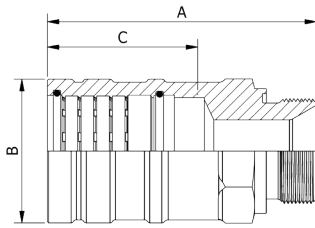

*MATERIAL CODE:
 K = STAINLESS STEEL
 G = CARBON STEEL
 B = COPPER NICKEL 70/30

ORDER EXAMPLE:
 DM20153G04

BSPP Male, NPS - DM20153

Size NPS	BSPP Size	Part Number	Dimensions - Inch (mm)				*Weight K & G lbs (kg)
			A	B	C Insertion Depth	D	
1/4"	1/4"	DM20153*04	2.13 (54.10)	0.80 (20.32)	1.13 (28.70)	0.75 (19.05)	0.14 (0.06)
3/8"	3/8"	DM20153*06	2.38 (60.45)	0.99 (25.15)	1.38 (35.05)	0.87 (22.10)	0.22 (0.10)
1/2"	1/2"	DM20153*08	3.00 (76.20)	1.20 (30.48)	1.50 (38.10)	1.18 (29.97)	0.46 (0.21)
3/4"	3/4"	DM20153*12	3.38 (85.85)	1.48 (37.59)	1.75 (44.45)	1.42 (36.07)	0.71 (0.32)
1"	1"	DM20153*16	3.63 (92.20)	1.82 (46.23)	2.00 (50.80)	1.81 (45.97)	1.14 (0.52)
1-1/4"	1-1/4"	DM20153*20	4.25 (107.95)	2.26 (57.40)	2.38 (60.45)	1.97 (50.04)	1.95 (0.88)
1-1/2"	1-1/2"	DM20153*24	4.63 (117.60)	2.58 (65.53)	2.50 (63.50)	2.17 (55.12)	2.67 (1.21)
2"	2"	DM20153*32	5.38 (136.65)	3.04 (77.22)	3.50 (88.90)	2.95 (74.93)	3.49 (1.58)

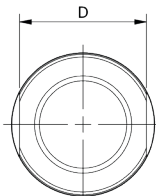
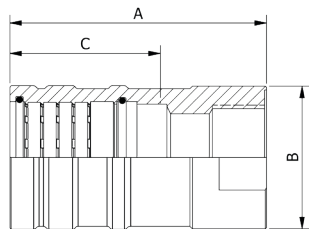

*MATERIAL CODE:
 K = STAINLESS STEEL
 G = CARBON STEEL
 B = COPPER NICKEL 70/30

ORDER EXAMPLE:
 DM20086G04

BSPP Female, NPS - DM20086

Size NPS	BSPP Size	Part Number	Dimensions - Inch (mm)				*Weight K & G lbs (kg)
			A	B	C Insertion Depth	D	
1/4"	1/4"	DM20086*04	2.00 (50.80)	0.88 (22.35)	1.13 (28.70)	0.75 (19.05)	0.15 (0.07)
3/8"	3/8"	DM20086*06	2.38 (60.45)	1.06 (26.92)	1.38 (35.05)	0.94 (23.88)	0.25 (0.11)
1/2"	1/2"	DM20086*08	2.63 (66.80)	1.25 (31.75)	1.50 (38.10)	1.06 (26.92)	0.40 (0.18)
3/4"	3/4"	DM20086*12	3.25 (82.55)	1.75 (44.45)	1.75 (44.45)	1.50 (38.10)	0.91 (0.41)
1"	1"	DM20086*16	3.50 (88.90)	2.00 (50.80)	2.00 (50.80)	1.75 (44.45)	1.28 (0.58)
1-1/4"	1-1/4"	DM20086*20	4.05 (102.87)	2.25 (57.15)	2.38 (60.45)	2.00 (50.80)	1.91 (0.87)
1-1/2"	1-1/2"	DM20086*24	4.38 (111.25)	2.75 (69.85)	2.50 (63.50)	2.50 (63.50)	2.88 (1.31)
2"	2"	DM20086*32	5.75 (146.05)	3.50 (88.90)	3.50 (88.90)	3.00 (76.20)	5.14 (2.33)

DM 20 Series - NPS Pipe

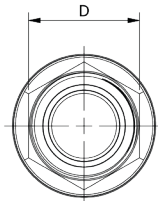
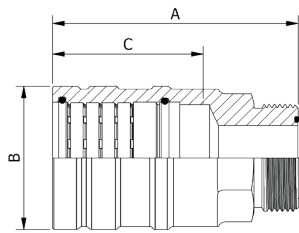

***MATERIAL CODE:**
K = STAINLESS STEEL
G = CARBON STEEL
B = COPPER NICKEL 70/30

ORDER EXAMPLE:
DM20010G04

ORFS Male, NPS - DM20010

Size NPS	ORFS Size	Part Number	Dimensions - Inch (mm)				*Weight K & G lbs (kg)
			A	B	C Insertion Depth	D	
1/4"	04	DM20010*04	2.13 (54.10)	0.80 (20.32)	1.13 (28.70)	0.63 (16.00)	0.13 (0.06)
3/8"	06	DM20010*06	2.50 (63.50)	0.99 (25.15)	1.38 (35.05)	0.75 (19.05)	0.23 (0.10)
1/2"	08	DM20010*08	2.75 (69.85)	1.20 (30.48)	1.50 (38.10)	0.88 (22.35)	0.34 (0.15)
3/4"	12	DM20010*12	3.25 (82.55)	1.48 (37.59)	1.75 (44.45)	1.25 (31.75)	0.69 (0.31)
1"	16	DM20010*16	3.50 (88.90)	1.82 (46.23)	2.00 (50.80)	1.50 (38.10)	1.18 (0.54)
1-1/4"	20	DM20010*20	4.08 (103.63)	2.26 (57.40)	2.38 (60.45)	1.75 (44.45)	1.80 (0.82)
1-1/2"	24	DM20010*24	4.38 (111.25)	2.58 (65.53)	2.50 (63.50)	2.13 (54.10)	2.53 (1.15)

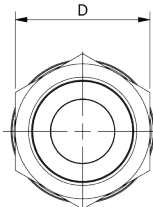
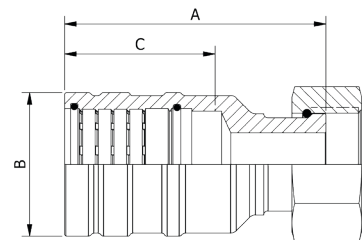

***MATERIAL CODE:**
K = STAINLESS STEEL
G = CARBON STEEL
B = COPPER NICKEL 70/30

ORDER EXAMPLE:
DM20020G04

ORFS Female Swivel, NPS - DM20020

Size NPS	ORFS Size	Part Number	Dimensions - Inch (mm)				*Weight K & G lbs (kg)
			A	B	C Insertion Depth	D	
1/4"	04	DM20020*04	2.25 (57.15)	0.80 (20.32)	1.13 (28.70)	0.67 (17.02)	0.14 (0.06)
3/8"	06	DM20020*06	2.50 (63.50)	0.99 (25.15)	1.38 (35.05)	0.86 (21.84)	0.26 (0.12)
1/2"	08	DM20020*08	2.75 (69.85)	1.20 (30.48)	1.50 (38.10)	0.94 (23.88)	0.33 (0.15)
3/4"	12	DM20020*12	3.50 (88.90)	1.48 (37.59)	1.75 (44.45)	1.63 (41.40)	1.04 (0.47)
1"	16	DM20020*16	3.63 (92.20)	1.82 (46.23)	2.00 (50.80)	1.75 (44.45)	1.31 (0.59)
1-1/4"	20	DM20020*20	4.13 (104.90)	2.26 (57.40)	2.38 (60.45)	2.13 (54.10)	2.21 (1.00)
1-1/2"	24	DM20020*24	4.38 (111.25)	2.58 (65.53)	2.50 (63.50)	2.38 (60.45)	2.95 (1.34)

3D step models available upon request

DM 20 Series - NPS Pipe

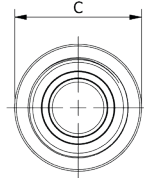
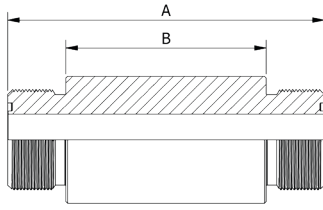

***MATERIAL CODE:**
 K = STAINLESS STEEL
 G = CARBON STEEL
 B = COPPER NICKEL 70/30

ORDER EXAMPLE:
 DM60089G08

Weldable Bulkhead, OD Tube - DM60089

Size NPS	ORFS Size	Part Number	Dimensions - Inch (mm)			Thread Details	*Weight K & G lbs (kg)
			A	B	C		
1/2"	08	DM60089*08	3.00 (76.20)	1.99 (50.55)	1.00 (25.40)	13/16"-16UNF-2A	0.49 (0.22)
3/4"	12	DM60089*12	3.75 (95.25)	2.37 (60.20)	1.50 (38.10)	1-3/16"-12UNF-2A	1.31 (0.59)
1"	16	DM60089*16	3.75 (95.25)	2.37 (60.20)	1.75 (44.45)	1-7/16"-12UNF-2A	1.70 (0.77)
1-1/4"	20	DM60089*20	4.00 (101.60)	2.62 (66.55)	2.00 (50.80)	1-11/16"-12UNF-2A	2.28 (1.03)
1-1/2"	24	DM60089*24	4.25 (107.95)	2.87 (72.90)	2.38 (60.45)	2"-12UNF-2A	2.89 (1.31)

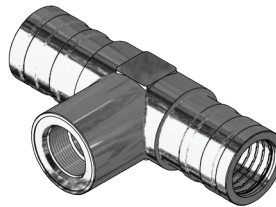
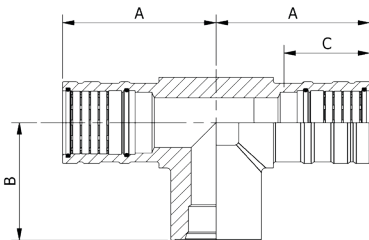

***MATERIAL CODE:**
 K = STAINLESS STEEL
 G = CARBON STEEL
 B = COPPER NICKEL 70/30

ORDER EXAMPLE:
 DM20171G04

SAE Female Branch Tee, NPS - DM20171

Size NPS	SAE Size	Part Number	Dimensions - Inch (mm)				*Weight K & G lbs (kg)
			A	B	C Insertion Depth	D	
1/4"	04	DM20171*04	1.75 (44.45)	1.38 (35.05)	1.13 (28.70)	0.86 (21.84)	0.41 (0.19)
3/8"	06	DM20171*06	2.00 (50.80)	1.63 (41.40)	1.38 (35.05)	1.06 (26.92)	0.71 (0.32)
1/2"	08	DM20171*08	2.68 (68.07)	2.25 (57.15)	1.50 (38.10)	1.30 (33.02)	1.44 (0.65)
3/4"	12	DM20171*12	3.03 (76.96)	2.50 (63.50)	1.75 (44.45)	1.58 (40.13)	2.26 (1.03)
1"	16	DM20171*16	3.37 (85.60)	2.88 (73.15)	2.00 (50.80)	1.97 (50.04)	3.83 (1.74)
1-1/4"	20	DM20171*20	4.25 (107.95)	3.25 (82.55)	2.38 (60.45)	2.50 (63.50)	7.40 (3.36)
1-1/2"	24	DM20171*24	4.54 (115.32)	3.50 (88.90)	2.50 (63.50)	2.81 (71.37)	10.06 (4.56)
2"	32	DM20171*32	5.45 (138.43)	4.00 (101.60)	3.50 (88.90)	3.25 (82.55)	14.11 (6.40)

DM 20 Series - NPS Pipe

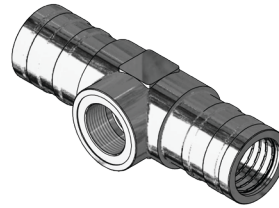
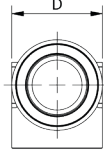
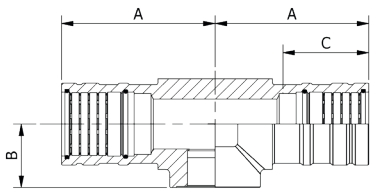

***MATERIAL CODE:**
 K = STAINLESS STEEL
 G = CARBON STEEL
 B = COPPER NICKEL 70/30

ORDER EXAMPLE:
 DM20172G04

BSPP Female Branch Tee, NPS - DM20172

Size NPS	BSPP Size	Part Number	Dimensions - Inch (mm)				*Weight K & G lbs (kg)
			A	B	C Insertion Depth	D	
1/4"	1/4"	DM20172*04	1.75 (44.45)	1.00 (25.40)	1.13 (28.70)	0.86 (21.84)	0.33 (0.15)
3/8"	3/8"	DM20172*06	2.00 (50.80)	1.00 (25.40)	1.38 (35.05)	1.06 (26.92)	0.54 (0.24)
1/2"	1/2"	DM20172*08	2.68 (68.07)	1.25 (31.75)	1.50 (38.10)	1.30 (33.02)	1.06 (0.48)
3/4"	3/4"	DM20172*12	3.03 (76.96)	1.25 (31.75)	1.75 (44.45)	1.58 (40.13)	1.60 (0.73)
1"	1"	DM20172*16	3.37 (85.60)	1.50 (38.10)	2.00 (50.80)	1.97 (50.04)	2.80 (1.27)
1-1/4"	1-1/4"	DM20172*20	4.25 (107.95)	1.75 (44.45)	2.38 (60.45)	2.50 (63.50)	5.89 (2.67)
1-1/2"	1-1/2"	DM20172*24	4.54 (115.32)	2.00 (50.80)	2.50 (63.50)	2.69 (68.33)	7.11 (3.23)
2"	2"	DM20172*32	5.45 (138.43)	2.38 (60.45)	3.50 (88.90)	3.25 (82.55)	10.48 (4.75)

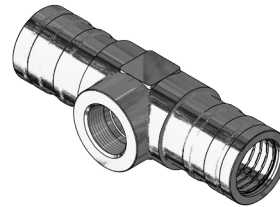
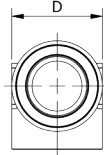
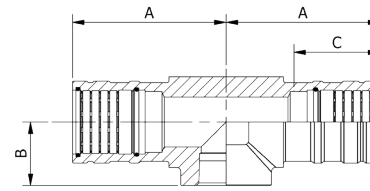

***MATERIAL CODE:**
 K = STAINLESS STEEL
 G = CARBON STEEL
 B = COPPER NICKEL 70/30

ORDER EXAMPLE:
 DM20173G04

NPT Female Branch Tee, NPS - DM20173















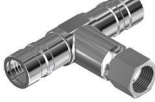















Size NPS	NPT Size	Part Number	Dimensions - Inch (mm)				*Weight K & G lbs (kg)
			A	B	C Insertion Depth	D	
1/4"	1/4"	DM20173*04	1.75 (44.45)	0.75 (19.05)	1.13 (28.70)	0.86 (21.84)	0.31 (0.14)
3/8"	3/8"	DM20173*06	2.00 (50.80)	1.00 (25.40)	1.38 (35.05)	1.06 (26.92)	0.56 (0.25)
1/2"	1/2"	DM20173*08	2.68 (68.07)	1.13 (28.70)	1.50 (38.10)	1.30 (33.02)	1.10 (0.50)
3/4"	3/4"	DM20173*12	3.03 (76.96)	1.25 (31.75)	1.75 (44.45)	1.58 (40.13)	1.70 (0.77)
1"	1"	DM20173*16	3.37 (85.60)	1.38 (35.05)	2.00 (50.80)	1.97 (50.04)	2.80 (1.27)
1-1/4"	1-1/4"	DM20173*20	4.25 (107.95)	1.75 (44.45)	2.38 (60.45)	2.50 (63.50)	5.70 (2.59)
1-1/2"	1-1/2"	DM20173*24	4.54 (115.32)	2.00 (50.80)	2.50 (63.50)	2.81 (71.37)	7.85 (3.56)
2"	2"	DM20173*32	5.45 (138.43)	2.00 (50.80)	3.50 (88.90)	3.25 (82.55)	13.60 (6.17)

3D step models available upon request

Specialty Fitting Configuration Guide

DM 20 Series - NPS Pipe

1/4" to 3"

					
JIC 37° 90° Elbow Male DM20355	JIC 37° Branch Tee Male DM20177	JIC 37° Run Tee Male DM20178	JIC 37° 90° Elbow Female Swivel DM20354	JIC 37° Branch Tee Female Swivel DM20170	NPT 90° Elbow Male DM20057
					
NPT Branch Tee Male DM20176	NPT Run Tee Male DM20181	NPT 90° Elbow Female DM20061	ORFS 90° Elbow Male DM20011	ORFS Branch Tee Male DM20013	ORFS Run Tee Male DM20014
					
ORFS 90° Elbow Female Swivel DM20021	ORFS Branch Tee Female Swivel DM20023	SAE 90° Elbow Male DM20105	SAE Branch Tee Male DM20174	SAE Run Tee Male DM20179	SAE 90° Elbow Female DM20387
					
BSPP 90° Elbow Male DM20168	BSPP Branch Tee Male DM20175	BSPP Run Tee Male DM20180	BSPP 90° Elbow Female DM20169	BSPP Cross Fitting with 2 Ports DM20221	BSPP Cross Fitting with 4 Ports DM20241
					
Flange - ANSI #900 DM20025	Flange - ANSI #1500 DM20026	Compact Elbow x Code 61 Flange DM20231	Compact Elbow x Code 62 Flange DM20232	90° PYPLOK® x SAE Code 61 Flange DM20391	90° PYPLOK® x SAE Code 62 Flange DM20392

Specialty Fitting Configuration Guide

DM 20 Series - NPS Pipe

1/4" to 3"

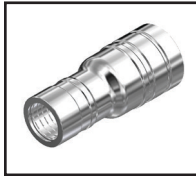

NPS to OD Tube Reducer
DM20501



NPS to Metric Tube Reducer
DM20801



CPV Female
DM20040



CPV Male Union
DM20041



Extra Long Coupling
DM20301

Introduction

Technical Information

DM 20 – NPS Pipe

DM 60 – OD Tube

DM 80 – Metric & JIS Tube

DP 40N – NPS Low Pressure

DP 40M – Metric Low Pressure

PYPLOK® Tooling

Installation Procedures

Appendix

General Characteristics

DM 60 Series – OD Tube

Fitting Material Specifications Material Specification

K = Stainless Steel	ASTM-A479/A182-316
G = Carbon Steel	ASTM-A105/A350 LF2
B = Copper Nickel 70/30	MIL-C71500
C = Copper Nickel 90/10	MIL-C70600
D = Duplex	ASTM-A479/A182-UNS31803
Z = Super Duplex	ASTM-A479/A182-UNS32750

O-Ring Material Specifications O-Ring Temperature Limits

VITON (Brown Colour)	-15°F to 400°F (-26°C to 205°C)
EPDM (Black Colour)	-60°F to 400°F (-51°C to 205°C)

For seal compatibility and selection for each system consult factory. Other seal materials for specific applications of compatibility and temperature are available upon request.

Ordering Information

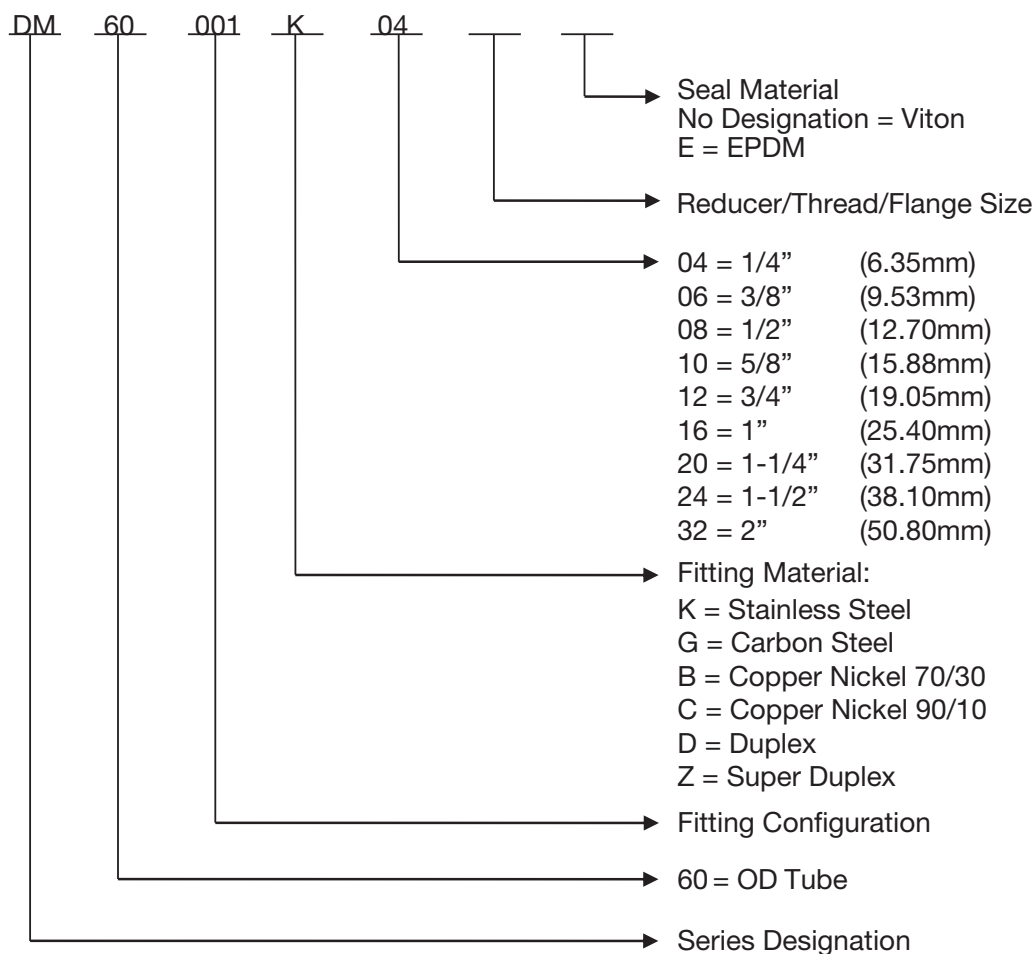





System design and safe application is the responsibility of the end-user. Consideration must be taken to confirm proper fitting selection is made to ensure proper compatibility, function and operation of the fitting within the piping system. The technical and performance information such as weights, dimensions and ratings in this catalogue supersede all previous published data. Tube-Mac® reserves the right to change technical data and product dimension, ratings and other aspects without notice.

Standard Fitting Configuration Guide

DM 60 Series - OD Tube

1/4" to 2"

					
Coupling DM60001 Page D3	Coupling with Inner Stop DM60002 Page D3	90° Elbow DM60003 Page D4	45° Elbow DM60017 Page D4	Tee DM60004 Page D5	Reducing Tee DM60104 Page D6
					
Reducer DM60101 Page D7	End Cap DM60085 Page D8	Flange - ANSI 150# DM60018 Page D9	Flange - ANSI 300# DM60019 Page D9	Flange - ANSI 600# DM60027 Page D10	SAE Flange Body DM60090 Page D10
					
SAE Code 61 Flange DM60091 Page D11	SAE Code 62 Flange DM60092 Page D11	SAE Code 61 Tapped Flange DM60095 Page D12	SAE Code 62 Tapped Flange DM60096 Page D12	JIC 37° Male DM60055 Page D13	JIC 37° Female Swivel DM60054 Page D13
					
NPT Male DM60056 Page D14	NPT Female DM60060 Page D14	SAE Male DM60088 Page D15	SAE Female DM60087 Page D15	BSPP Male DM60153 Page D16	BSPP Female DM60086 Page D16
					
ORFS Male DM60010 Page D17	ORFS Female Swivel DM60020 Page D17	Weldable Bulkhead DM60089 Page D18	SAE Female Branch Tee DM60171 Page D18	BSPP Female Branch Tee DM60172 Page D19	NPT Female Branch Tee DM60173 Page D19

DM 60 Series – OD Tube

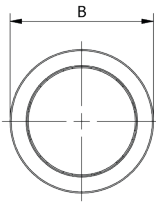
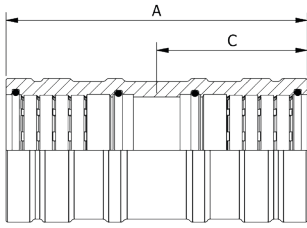

***MATERIAL CODE:**
 K = STAINLESS STEEL
 G = CARBON STEEL
 B = COPPER NICKEL 70/30

ORDER EXAMPLE:
 DM60001G04

Coupling, OD Tube - DM60001

Size OD	Part Number	Dimensions - Inch (mm)			*Weight K & G lbs (kg)
		A	B	C Insertion Depth	
1/4"	DM60001*04	1.51 (38.35)	0.39 (9.91)	0.75 (19.05)	0.02 (0.01)
3/8"	DM60001*06	1.84 (46.74)	0.55 (13.97)	0.92 (23.37)	0.05 (0.02)
1/2"	DM60001*08	2.18 (55.37)	0.75 (19.05)	1.09 (27.69)	0.11 (0.05)
5/8"	DM60001*10	2.52 (64.01)	0.93 (23.62)	1.26 (32.00)	0.21 (0.10)
3/4"	DM60001*12	2.85 (72.39)	1.09 (27.69)	1.42 (36.07)	0.30 (0.14)
1"	DM60001*16	3.41 (86.61)	1.41 (35.81)	1.70 (43.18)	0.61 (0.28)
1-1/4"	DM60001*20	3.88 (98.55)	1.73 (43.94)	1.94 (49.28)	1.04 (0.47)
1-1/2"	DM80001*38	4.29 (108.97)	2.05 (52.07)	2.15 (54.61)	1.57 (0.71)
2"	DM60001*32	5.00 (127.00)	2.58 (65.53)	2.50 (63.50)	2.49 (1.13)

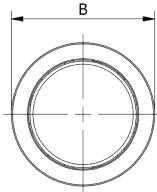
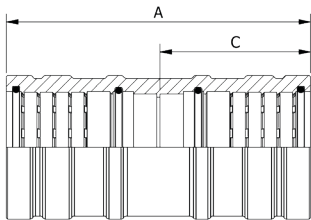

***MATERIAL CODE:**
 K = STAINLESS STEEL
 G = CARBON STEEL
 B = COPPER NICKEL 70/30

ORDER EXAMPLE:
 DM60002G04

Coupling with Inner Stop, OD Tube - DM60002

Size OD	Part Number	Dimensions - Inch (mm)			*Weight K & G lbs (kg)
		A	B	C Insertion Depth	
1/4"	DM60002*04	1.56 (39.52)	0.39 (9.91)	0.75 (19.05)	0.02 (0.01)
3/8"	DM60002*06	1.89 (47.96)	0.55 (13.97)	0.92 (23.37)	0.05 (0.02)
1/2"	DM60002*08	2.23 (56.59)	0.75 (19.05)	1.09 (27.69)	0.11 (0.05)
5/8"	DM60002*10	2.57 (65.28)	0.93 (23.62)	1.26 (32.00)	0.21 (0.10)
3/4"	DM60002*12	2.90 (73.56)	1.09 (27.69)	1.42 (36.07)	0.30 (0.14)
1"	DM60002*16	3.46 (87.78)	1.41 (35.81)	1.70 (43.18)	0.61 (0.28)
1-1/4"	DM60002*20	3.93 (99.85)	1.73 (43.94)	1.94 (49.28)	1.04 (0.47)
1-1/2"	DM80002*38	4.34 (110.24)	2.05 (52.07)	2.15 (54.61)	1.57 (0.71)
2"	DM60002*32	5.05 (128.27)	2.58 (65.53)	2.50 (63.50)	2.49 (1.13)

3D step models available upon request

DM 60 Series – OD Tube

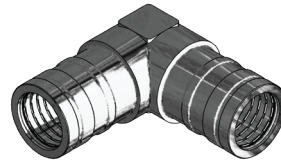
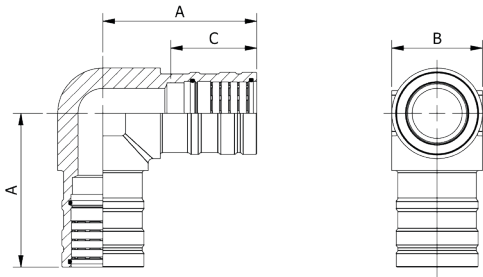

***MATERIAL CODE:**
 K = STAINLESS STEEL
 G = CARBON STEEL
 B = COPPER NICKEL 70/30

ORDER EXAMPLE:
 DM60003G04

90° Elbow, OD Tube - DM60003

Size OD	Part Number	Dimensions - Inch (mm)			*Weight K & G lbs (kg)
		A	B	C Insertion Depth	
1/4"	DM60003*04	1.20 (30.43)	0.47 (11.94)	0.75 (19.05)	0.05 (0.02)
3/8"	DM60003*06	1.50 (38.10)	0.63 (16.00)	0.92 (23.37)	0.12 (0.05)
1/2"	DM60003*08	1.75 (44.45)	0.86 (21.84)	1.09 (27.69)	0.26 (0.12)
5/8"	DM60003*10	2.00 (50.80)	1.06 (26.92)	1.26 (32.00)	0.47 (0.21)
3/4"	DM60003*12	2.68 (68.07)	1.30 (33.02)	1.42 (36.07)	0.91 (0.41)
1"	DM60003*16	3.03 (76.96)	1.58 (40.13)	1.70 (43.18)	1.54 (0.70)
1-1/4"	DM60003*20	3.40 (86.36)	1.97 (50.04)	1.94 (49.28)	2.70 (1.22)
1-1/2"	DM80003*38	4.25 (107.95)	2.50 (63.50)	2.15 (54.61)	5.42 (2.46)
2"	DM60003*32	4.54 (115.32)	2.81 (71.37)	2.50 (63.50)	6.85 (3.11)

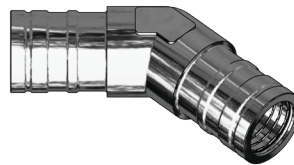
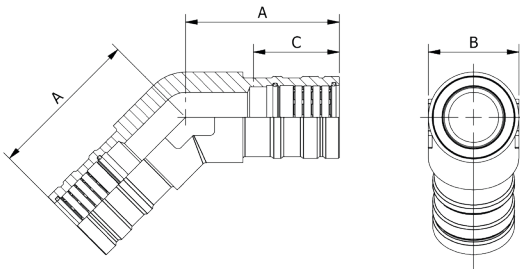

***MATERIAL CODE:**
 K = STAINLESS STEEL
 G = CARBON STEEL
 B = COPPER NICKEL 70/30

ORDER EXAMPLE:
 DM60017G04

45° Elbow, OD Tube - DM60017

Size OD	Part Number	Dimensions - Inch (mm)			*Weight K & G lbs (kg)
		A	B	C Insertion Depth	
1/4"	DM60017*04	1.20 (30.43)	0.47 (11.94)	0.75 (19.05)	0.05 (0.02)
3/8"	DM60017*06	1.50 (38.10)	0.63 (16.00)	0.92 (23.37)	0.12 (0.05)
1/2"	DM60017*08	1.75 (44.45)	0.86 (21.84)	1.09 (27.69)	0.27 (0.12)
5/8"	DM60017*10	2.00 (50.80)	1.06 (26.92)	1.26 (32.00)	0.48 (0.22)
3/4"	DM60017*12	2.68 (68.07)	1.30 (33.02)	1.42 (36.07)	0.92 (0.42)
1"	DM60017*16	3.03 (76.96)	1.58 (40.13)	1.70 (43.18)	1.57 (0.71)
1-1/4"	DM60017*20	3.40 (86.36)	1.97 (50.04)	1.94 (49.28)	2.76 (1.25)
1-1/2"	DM80017*38	4.25 (107.95)	2.50 (63.50)	2.15 (54.61)	5.08 (2.30)
2"	DM60017*32	4.54 (115.32)	2.81 (71.37)	2.50 (63.50)	7.17 (3.25)

DM 60 Series – OD Tube

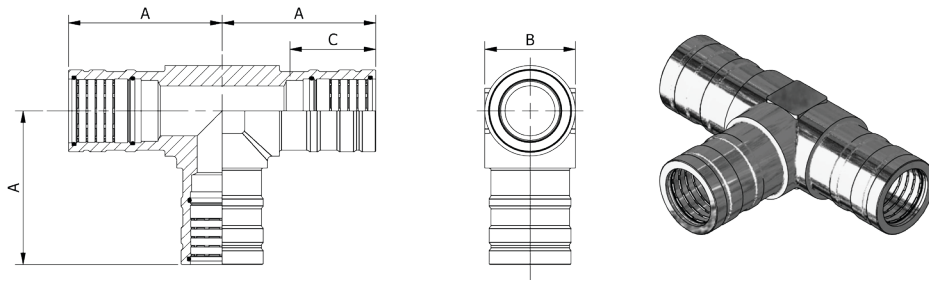

***MATERIAL CODE:**
K = STAINLESS STEEL
G = CARBON STEEL
B = COPPER NICKEL 70/30

ORDER EXAMPLE:
DM60004G04

Tee, OD Tube - DM60004

Size OD	Part Number	Dimensions - Inch (mm)			*Weight K & G lbs (kg)
		A	B	C Insertion Depth	
1/4"	DM60004*04	1.20 (30.43)	0.47 (11.94)	0.75 (19.05)	0.07 (0.03)
3/8"	DM60004*06	1.50 (38.10)	0.63 (16.00)	0.92 (23.37)	0.16 (0.07)
1/2"	DM60004*08	1.75 (44.45)	0.86 (21.84)	1.09 (27.69)	0.35 (0.16)
5/8"	DM60004*10	2.00 (50.80)	1.06 (26.92)	1.26 (32.00)	0.63 (0.29)
3/4"	DM60004*12	2.68 (68.07)	1.30 (33.02)	1.42 (36.07)	1.22 (0.55)
1"	DM60004*16	3.03 (76.96)	1.58 (40.13)	1.70 (43.18)	2.08 (0.94)
1-1/4"	DM60004*20	3.40 (86.36)	1.97 (50.04)	1.94 (49.28)	3.48 (1.58)
1-1/2"	DM80004*38	4.25 (107.95)	2.50 (63.50)	2.15 (54.61)	6.61 (3.00)
2"	DM60004*32	4.54 (115.32)	2.81 (71.37)	2.50 (63.50)	9.19 (4.17)

3D step models available upon request

DM 60 Series – OD Tube

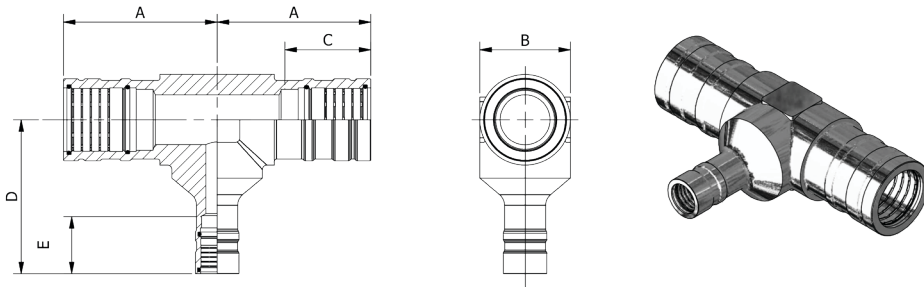

***MATERIAL CODE:**
 K = STAINLESS STEEL
 G = CARBON STEEL
 B = COPPER NICKEL 70/30

ORDER EXAMPLE:
 DM60104G0604

Other configurations available.
 Contact factory for details.

Reducing Tee, OD Tube - DM60104

Run Size OD	Branch Size OD	Part Number	Dimensions - Inch (mm)					*Weight K & G lbs (kg)
			A	B	C Insertion Depth	D	E Insertion Depth	
3/8"	1/4"	DM60104*0604	1.50 (38.10)	0.63 (16.00)	0.92 (23.37)	1.50 (38.10)	0.75 (19.05)	0.16 (0.07)
1/2"	1/4"	DM60104*0804	1.75 (44.45)	0.86 (21.84)	1.09 (27.69)	1.75 (44.45)	0.75 (19.05)	0.34 (0.15)
1/2"	3/8"	DM60104*0806	1.75 (44.45)	0.86 (21.84)	1.09 (27.69)	1.75 (44.45)	0.92 (23.37)	0.33 (0.15)
5/8"	3/8"	DM60104*1006	2.00 (50.80)	1.06 (26.92)	1.26 (32.00)	1.75 (44.45)	0.92 (23.37)	0.55 (0.25)
5/8"	1/2"	DM60104*1008	2.00 (50.80)	1.06 (26.92)	1.26 (32.00)	2.00 (50.80)	1.09 (27.69)	0.59 (0.27)
3/4"	5/8"	DM60104*1210	2.68 (68.07)	1.30 (33.02)	1.42 (36.07)	2.68 (68.07)	1.26 (32.00)	1.16 (0.53)
1"	1/2"	DM60104*1608	3.03 (76.96)	1.58 (40.13)	1.70 (43.18)	3.03 (76.96)	1.09 (27.69)	2.05 (0.93)
1"	5/8"	DM60104*1610	3.03 (76.96)	1.58 (40.13)	1.70 (43.18)	3.03 (76.96)	1.26 (32.00)	2.03 (0.92)
1"	3/4"	DM60104*1612	3.03 (76.96)	1.58 (40.13)	1.70 (43.18)	3.03 (76.96)	1.42 (36.07)	1.92 (0.87)
1-1/4"	1/2"	DM60104*2008	3.40 (86.36)	1.97 (50.04)	1.94 (49.28)	3.03 (76.95)	1.09 (27.69)	3.46 (1.57)
1-1/4"	3/4"	DM60104*2012	3.40 (86.36)	1.97 (50.04)	1.94 (49.28)	3.37 (85.60)	1.42 (36.07)	3.27 (1.48)
1-1/4"	1"	DM60104*2016	3.40 (86.36)	1.97 (50.04)	1.94 (49.28)	3.37 (85.60)	1.70 (43.18)	3.42 (1.55)
1-1/2"	3/4"	DM60104*2412	4.25 (107.95)	2.50 (63.50)	2.15 (54.61)	3.75 (95.25)	1.42 (36.07)	6.77 (3.07)
1-1/2"	1"	DM60104*2416	4.25 (107.95)	2.50 (63.50)	2.15 (54.61)	4.25 (107.95)	1.70 (43.18)	6.84 (3.10)
1-1/2"	1-1/4"	DM60104*2420	4.25 (107.95)	2.50 (63.50)	2.15 (54.61)	4.25 (107.95)	1.94 (49.28)	6.85 (3.11)
2"	1"	DM60104*3216	4.54 (115.32)	2.81 (71.37)	2.50 (63.50)	4.54 (115.32)	1.70 (43.18)	8.90 (4.04)
2"	1-1/4"	DM60104*3220	4.54 (115.32)	2.81 (71.37)	2.50 (63.50)	4.54 (115.32)	1.94 (49.28)	9.02 (4.09)
2"	1-1/2"	DM60104*3224	4.54 (115.32)	2.81 (71.37)	2.50 (63.50)	4.54 (115.32)	2.20 (55.88)	8.95 (4.06)

DM 60 Series – OD Tube

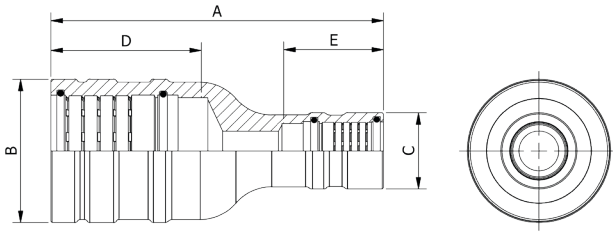

***MATERIAL CODE:**
 K = STAINLESS STEEL
 G = CARBON STEEL
 B = COPPER NICKEL 70/30

ORDER EXAMPLE:
 DM60101G0604

Other configurations available.
 Contact factory for details.

Reducer, OD Tube - DM60101

End 1 Size OD	End 2 Size OD	Part Number	Dimensions - Inch (mm)					*Weight K & G lbs (kg)
			A	B	C	D Insertion Depth	E Insertion Depth	
3/8"	1/4"	DM60101*0604	2.00 (50.80)	0.55 (13.97)	0.39 (9.91)	0.92 (23.37)	0.75 (19.05)	0.04 (0.02)
1/2"	1/4"	DM60101*0804	2.25 (57.15)	0.75 (19.05)	0.39 (9.91)	1.09 (27.69)	0.75 (19.05)	0.08 (0.04)
1/2"	3/8"	DM60101*0806	2.38 (60.45)	0.75 (19.05)	0.55 (13.97)	1.09 (27.69)	0.92 (23.37)	0.09 (0.04)
5/8"	3/8"	DM60101*1006	2.88 (73.15)	0.93 (23.62)	0.55 (13.97)	1.26 (32.00)	0.92 (23.37)	0.15 (0.07)
5/8"	1/2"	DM60101*1008	2.88 (73.15)	0.93 (23.62)	0.75 (19.05)	1.26 (32.00)	1.09 (27.69)	0.16 (0.07)
3/4"	1/2"	DM60101*1208	3.50 (88.90)	1.09 (27.69)	0.75 (19.05)	1.42 (36.07)	1.09 (27.69)	0.28 (0.13)
3/4"	5/8"	DM60101*1210	3.50 (88.90)	1.09 (27.69)	0.93 (23.62)	1.42 (36.07)	1.26 (32.00)	0.33 (0.15)
1"	5/8"	DM60101*1610	3.63 (92.20)	1.41 (35.81)	0.93 (23.62)	1.70 (43.18)	1.26 (32.00)	0.53 (0.24)
1"	3/4"	DM60101*1612	4.25 (107.95)	1.41 (35.81)	1.09 (27.69)	1.70 (43.18)	1.42 (36.07)	0.62 (0.28)
1-1/4"	3/4"	DM60101*2012	4.50 (114.30)	1.73 (43.94)	1.09 (27.69)	1.94 (49.28)	1.42 (36.07)	0.87 (0.39)
1-1/4"	1"	DM60101*2016	4.50 (114.30)	1.73 (43.94)	1.41 (35.81)	1.94 (49.28)	1.70 (43.18)	1.05 (0.48)
1-1/2"	1"	DM60101*2416	5.00 (127.00)	2.05 (52.07)	1.41 (35.81)	2.15 (54.61)	1.70 (43.18)	1.55 (0.70)
1-1/2"	1-1/4"	DM60101*2420	5.00 (127.00)	2.05 (52.07)	1.73 (43.94)	2.15 (54.61)	1.94 (49.28)	1.65 (0.75)
2"	1-1/4"	DM60101*3220	5.75 (146.05)	2.58 (65.53)	1.73 (43.94)	2.50 (63.50)	1.94 (49.28)	2.59 (1.17)
2"	1-1/2"	DM60101*3224	6.00 (152.40)	2.58 (65.53)	2.06 (52.32)	2.50 (63.50)	2.20 (55.88)	2.90 (1.32)

DM 60 Series – OD Tube

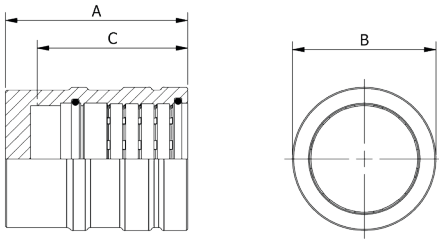

**MATERIAL CODE:
K = STAINLESS STEEL
G = CARBON STEEL
B = COPPER NICKEL 70/30*

*ORDER EXAMPLE:
DM60085G04*

End Cap, OD Tube - DM60085

Size OD	Part Number	Dimensions - Inch (mm)			*Weight K & G lbs (kg)
		A	B	C Insertion Depth	
1/4"	DM60085*04	1.00 (25.40)	0.39 (9.91)	0.75 (19.05)	0.02 (0.01)
3/8"	DM60085*06	1.25 (31.75)	0.55 (13.97)	0.92 (23.37)	0.04 (0.02)
1/2"	DM60085*08	1.38 (35.05)	0.75 (19.05)	1.09 (27.69)	0.08 (0.04)
5/8"	DM60085*10	1.50 (38.10)	0.93 (23.62)	1.26 (32.00)	0.13 (0.06)
3/4"	DM60085*12	1.75 (44.45)	1.09 (27.69)	1.42 (36.07)	0.21 (0.10)
1"	DM60085*16	2.25 (57.15)	1.41 (35.81)	1.70 (43.18)	0.50 (0.23)
1-1/4"	DM60085*20	2.38 (60.45)	1.73 (43.94)	1.94 (49.28)	0.75 (0.34)
1-1/2"	DM80085*38	2.63 (66.80)	2.05 (52.07)	2.15 (54.61)	1.36 (0.62)
2"	DM60085*32	3.00 (76.20)	2.58 (65.53)	2.50 (63.50)	1.80 (0.82)

DM 60 Series – OD Tube

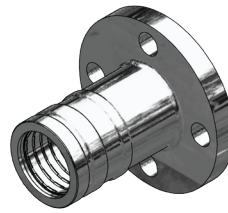
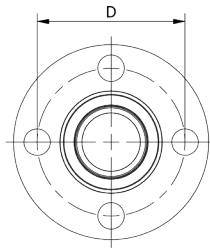
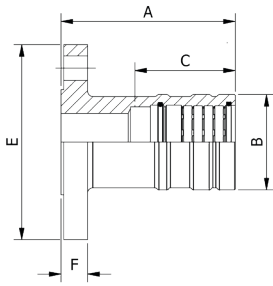

*MATERIAL CODE:
 K = STAINLESS STEEL
 G = CARBON STEEL
 B = COPPER NICKEL 70/30

ORDER EXAMPLE:
 DM60018G08

Flange – ANSI 150#, OD Tube - DM60018

Size OD	Flange Size	Part Number	Dimensions - Inch (mm)						Bolt Size	*Weight K & G lbs (kg)
			A	B	C Insertion Depth	D	E	F		
1/2"	1/2"	DM60018*08	2.38 (60.45)	0.75 (19.05)	1.09 (27.69)	2.38 (60.45)	3.50 (88.90)	0.44 (11.18)	1/2" UNC	1.06 (0.48)
3/4"	3/4"	DM60018*12	3.13 (79.50)	1.09 (27.69)	1.42 (36.07)	2.75 (69.85)	3.88 (98.55)	0.50 (12.70)	1/2" UNC	1.69 (0.77)
1"	1"	DM60018*16	3.63 (92.20)	1.41 (35.81)	1.70 (43.18)	3.12 (79.25)	4.25 (107.95)	0.56 (14.22)	1/2" UNC	2.73 (1.24)
1-1/4"	1-1/4"	DM60018*20	4.00 (101.60)	1.73 (43.94)	1.94 (49.28)	3.50 (88.90)	4.62 (117.35)	0.63 (16.00)	1/2" UNC	3.51 (1.59)
1-1/2"	1-1/2"	DM60018*24	4.25 (107.95)	2.05 (52.07)	2.15 (54.61)	3.88 (98.55)	5.00 (127.00)	0.75 (19.05)	1/2" UNC	4.98 (2.26)
2"	2"	DM60018*32	5.50 (139.70)	2.58 (65.53)	2.50 (63.50)	4.75 (120.65)	6.00 (152.40)	0.75 (19.05)	5/8" UNC	7.66 (3.47)

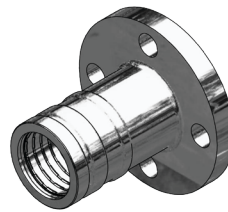
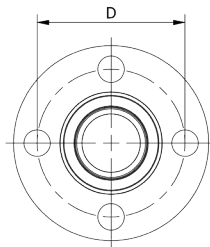
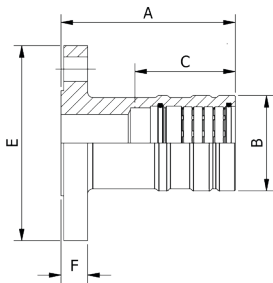

*MATERIAL CODE:
 K = STAINLESS STEEL
 G = CARBON STEEL
 B = COPPER NICKEL 70/30

ORDER EXAMPLE:
 DM60019G08

Flange – ANSI 300#, OD Tube - DM60019

Size OD	Flange Size	Part Number	Dimensions - Inch (mm)						Bolt Size	*Weight K & G lbs (kg)
			A	B	C Insertion Depth	D	E	F		
1/2"	1/2"	DM60019*08	2.88 (73.15)	0.75 (19.05)	1.09 (27.69)	2.63 (66.80)	3.75 (95.25)	0.56 (14.22)	1/2" UNC	1.67 (0.76)
3/4"	3/4"	DM60019*12	3.75 (95.25)	1.09 (27.69)	1.42 (36.07)	3.25 (82.55)	4.62 (117.35)	0.63 (16.00)	5/8" UNC	3.00 (1.36)
1"	1"	DM60019*16	3.88 (98.55)	1.41 (35.81)	1.70 (43.18)	3.50 (88.90)	4.88 (123.95)	0.69 (17.53)	5/8" UNC	3.79 (1.72)
1-1/4"	1-1/4"	DM60019*20	4.25 (107.95)	1.73 (43.94)	1.94 (49.28)	3.88 (98.55)	5.25 (133.35)	0.75 (19.05)	5/8" UNC	5.07 (2.30)
1-1/2"	1-1/2"	DM60019*24	4.50 (114.30)	2.05 (52.07)	2.20 (55.88)	4.50 (114.30)	6.12 (155.45)	0.81 (20.57)	3/4" UNC	7.37 (3.34)
**2"	2"	DM60019*32	5.13 (130.30)	2.58 (65.53)	2.50 (63.50)	5.00 (127.00)	6.50 (165.10)	0.88 (22.35)	5/8" UNC	9.09 (4.12)

**2" ANSI 300# Flange has 8 Bolts.

3D step models available upon request

DM 60 Series – OD Tube

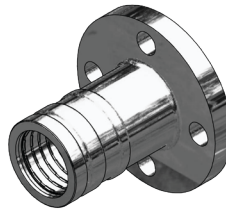
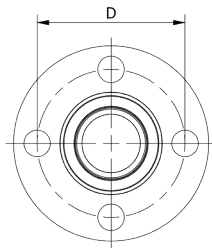
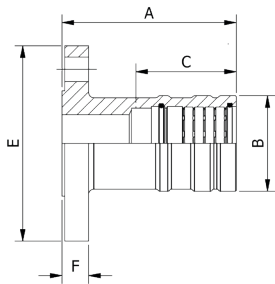

***MATERIAL CODE:**
 K = STAINLESS STEEL
 G = CARBON STEEL
 B = COPPER NICKEL 70/30

ORDER EXAMPLE:
 DM60027G08

Flange – ANSI 600#, OD Tube - DM60027

Size OD	Flange Size	Part Number	Dimensions - Inch (mm)						Bolt Size	*Weight K & G lbs (kg)
			A	B	C Insertion Depth	D	E	F		
1/2"	1/2"	DM60027*08	3.13 (79.50)	0.75 (19.05)	1.09 (27.69)	2.63 (66.80)	3.75 (95.25)	0.81 (20.57)	1/2" UNC	1.92 (0.87)
3/4"	3/4"	DM60027*12	3.75 (95.25)	1.09 (27.69)	1.42 (36.07)	3.25 (82.55)	4.63 (117.60)	0.88 (22.35)	5/8" UNC	3.31 (1.51)
1"	1"	DM60027*16	3.88 (98.55)	1.41 (35.81)	1.70 (43.18)	3.50 (88.90)	4.88 (123.95)	0.94 (23.88)	5/8" UNC	4.31 (1.51)
1-1/4"	1-1/4"	DM60027*20	4.50 (114.30)	1.73 (43.94)	1.94 (49.28)	3.88 (98.55)	5.25 (133.35)	1.06 (26.92)	5/8" UNC	6.04 (2.74)
1-1/2"	1-1/2"	DM60027*24	4.63 (117.60)	2.05 (52.07)	2.15 (54.61)	4.50 (98.55)	6.13 (155.70)	1.13 (28.70)	3/4" UNC	8.45 (3.83)
2"	2"	DM60027*32	5.75 (146.05)	2.58 (65.53)	2.50 (63.50)	5.00 (127.00)	6.50 (165.10)	1.25 (31.75)	5/8" UNC	10.41 (4.72)

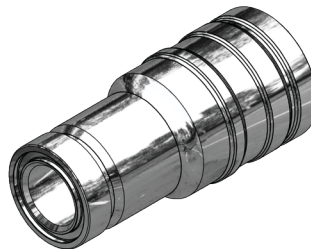
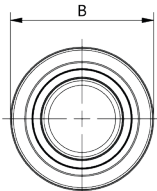
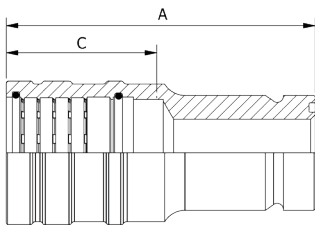

***MATERIAL CODE:**
 K = STAINLESS STEEL
 G = CARBON STEEL
 B = COPPER NICKEL 70/30

ORDER EXAMPLE:
 DM60090G08

SAE Flange Body, OD Tube - DM60090

Size OD	Flange Size	Part Number	Dimensions - Inch (mm)			*Weight K & G lbs (kg)
			A	B	C Insertion Depth	
1/2"	1/2"	DM60090*08	2.50 (63.50)	0.75 (19.05)	1.09 (27.69)	0.28 (0.13)
3/4"	3/4"	DM60090*12	3.38 (85.85)	1.09 (27.69)	1.42 (36.07)	0.66 (0.30)
1"	1"	DM60090*16	3.50 (88.90)	1.41 (35.81)	1.70 (43.18)	0.87 (0.39)
1-1/4"	1-1/4"	DM60090*20	4.00 (101.60)	1.73 (43.94)	1.94 (49.28)	2.23 (1.01)
1-1/2"	1-1/2"	DM80090*3824	4.43 (112.52)	2.05 (52.07)	2.15 (54.61)	2.13 (0.97)
2"	2"	DM60090*32	5.63 (143.00)	2.58 (65.53)	2.50 (63.50)	3.49 (1.58)

DM 60 Series – OD Tube

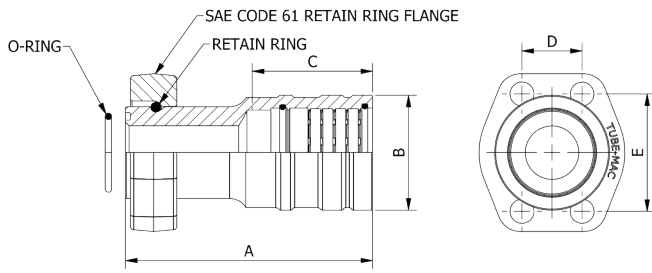

***MATERIAL CODE:**
 K = STAINLESS STEEL
 G = CARBON STEEL
 B = COPPER NICKEL 70/30

ORDER EXAMPLE:
 DM60091G08

SAE Code 61 Flange, OD Tube - DM60091

Size OD	Flange Size	Part Number	Dimensions - Inch (mm)					Bolt Minimum Grade 8	*Weight K & G lbs (kg)
			A	B	C Insertion Depth	D	E		
1/2"	1/2"	DM60091*08	2.50 (63.50)	0.75 (19.05)	1.09 (27.69)	0.69 (17.53)	1.50 (38.10)	5/16" UNC	0.74 (0.34)
3/4"	3/4"	DM60091*12	3.38 (85.85)	1.09 (27.69)	1.42 (36.07)	0.88 (22.35)	1.88 (47.75)	3/8" UNC	1.16 (0.53)
1"	1"	DM60091*16	3.50 (88.90)	1.41 (35.81)	1.70 (43.18)	1.03 (26.16)	2.06 (52.32)	3/8" UNC	1.50 (0.68)
1-1/4"	1-1/4"	DM60091*20	4.00 (101.60)	1.73 (43.94)	1.94 (49.28)	1.19 (30.23)	2.31 (58.67)	7/16" UNC	3.13 (1.42)
1-1/2"	1-1/2"	DM80091*3824	4.50 (114.30)	2.05 (52.07)	2.15 (54.61)	1.41 (35.81)	2.75 (69.85)	1/2" UNC	3.48 (1.58)
2"	2"	DM60091*32	5.63 (143.00)	2.58 (65.53)	2.50 (63.50)	1.69 (42.93)	3.06 (77.72)	1/2" UNC	5.51 (2.50)

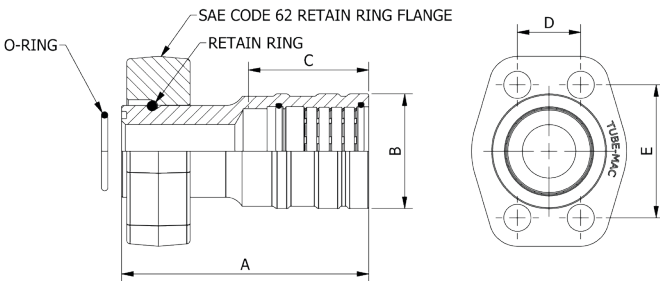

***MATERIAL CODE:**
 K = STAINLESS STEEL
 G = CARBON STEEL
 B = COPPER NICKEL 70/30

ORDER EXAMPLE:
 DM60092G08

SAE Code 62 Flange, OD Tube - DM60092

Size OD	Flange Size	Part Number	Dimensions - Inch (mm)					Bolt Minimum Grade 8	*Weight K & G lbs (kg)
			A	B	C Insertion Depth	D	E		
1/2"	1/2"	DM60092*08	2.50 (63.50)	0.75 (19.05)	1.09 (27.69)	0.72 (18.29)	1.59 (40.39)	5/16" UNC	0.74 (0.34)
3/4"	3/4"	DM60092*12	3.38 (85.85)	1.09 (27.69)	1.42 (36.07)	0.94 (23.88)	2.00 (50.80)	3/8" UNC	1.47 (0.67)
1"	1"	DM60092*16	3.50 (88.90)	1.41 (35.81)	1.70 (43.18)	1.09 (27.69)	2.25 (57.15)	7/16" UNC	2.13 (0.97)
1-1/4"	1-1/4"	DM60092*20	4.00 (101.60)	1.73 (43.94)	1.94 (49.28)	1.25 (31.75)	2.62 (66.50)	1/2" UNC	4.18 (1.90)
1-1/2"	1-1/2"	DM80092*3824	4.50 (114.30)	2.05 (52.07)	2.15 (54.61)	1.44 (36.58)	3.13 (79.50)	5/8" UNC	5.01 (2.27)
2"	2"	DM60092*32	5.63 (143.00)	2.58 (65.53)	2.50 (63.50)	1.75 (44.45)	3.81 (96.77)	3/4" UNC	8.89 (4.03)

DM 60 Series – OD Tube

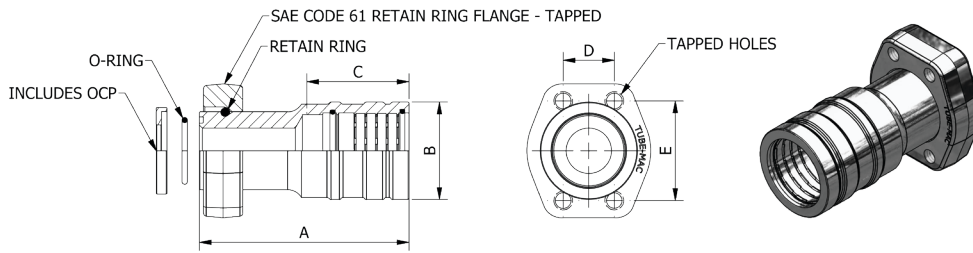

*MATERIAL CODE:
 K = STAINLESS STEEL
 G = CARBON STEEL
 B = COPPER NICKEL 70/30

ORDER EXAMPLE:
 DM60095G08

SAE Code 61 Tapped Flange, OD Tube - DM60095

Size OD	Flange Size	Part Number	Dimensions - Inch (mm)					Tap UNC-2B	*Weight K & G lbs (kg)
			A	B	C Insertion Depth	D	E		
1/2"	1/2"	DM60095*08	2.50 (63.50)	0.75 (19.05)	1.09 (27.69)	0.69 (17.53)	1.50 (38.10)	5/16"-18	0.74 (0.34)
3/4"	3/4"	DM60095*12	3.38 (85.85)	1.09 (27.69)	1.42 (36.07)	0.88 (22.35)	1.88 (47.75)	3/8"-16	1.16 (0.53)
1"	1"	DM60095*16	3.50 (88.90)	1.41 (35.81)	1.70 (43.18)	1.03 (26.16)	2.06 (52.32)	3/8"-16	1.50 (0.68)
1-1/4"	1-1/4"	DM60095*20	4.00 (101.60)	1.73 (43.94)	1.94 (49.28)	1.19 (30.23)	2.31 (58.67)	7/16"-14	3.13 (1.42)
1-1/2"	1-1/2"	DM60095*24	4.50 (114.30)	2.05 (52.07)	2.15 (54.61)	1.41 (35.81)	2.75 (69.85)	1/2"-13	3.48 (1.58)
2"	2"	DM60095*32	5.63 (143.00)	2.58 (65.53)	2.50 (63.50)	1.69 (42.93)	3.06 (77.72)	1/2"-13	5.51 (2.50)

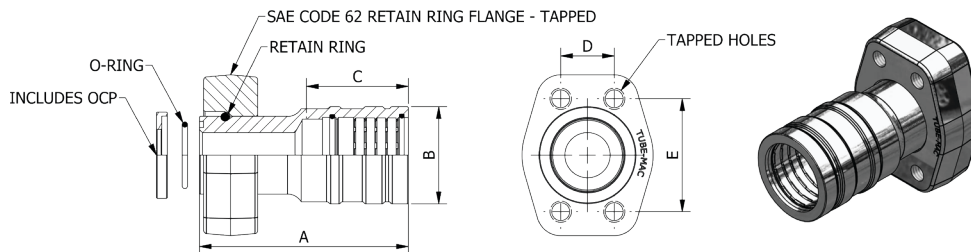

*MATERIAL CODE:
 K = STAINLESS STEEL
 G = CARBON STEEL
 B = COPPER NICKEL 70/30

ORDER EXAMPLE:
 DM60096G08

SAE Code 62 Tapped Flange, OD Tube - DM60096

Size OD	Flange Size	Part Number	Dimensions - Inch (mm)					Tap UNC-2B	*Weight K & G lbs (kg)
			A	B	C Insertion Depth	D	E		
1/2"	1/2"	DM60096*08	2.50 (63.50)	0.75 (19.05)	1.09 (27.69)	0.72 (18.29)	1.59 (40.39)	5/16"-18	0.74 (0.34)
3/4"	3/4"	DM60096*12	3.38 (85.85)	1.09 (27.69)	1.42 (36.07)	0.94 (23.88)	2.00 (50.80)	3/8"-16	1.47 (0.67)
1"	1"	DM60096*16	3.50 (88.90)	1.41 (35.81)	1.70 (43.18)	1.09 (27.69)	2.25 (57.15)	7/16"-14	2.13 (0.97)
1-1/4"	1-1/4"	DM60096*20	4.00 (101.60)	1.73 (43.94)	1.94 (49.28)	1.25 (31.75)	2.62 (66.50)	1/2"-13	4.18 (1.90)
1-1/2"	1-1/2"	DM60096*24	4.50 (114.30)	2.05 (52.07)	2.15 (54.61)	1.44 (36.58)	3.13 (79.50)	5/8"-11	5.01 (2.27)
2"	2"	DM60096*32	5.63 (143.00)	2.58 (65.53)	2.50 (63.50)	1.75 (44.45)	3.81 (96.77)	3/4"-10	8.89 (4.03)

DM 60 Series – OD Tube

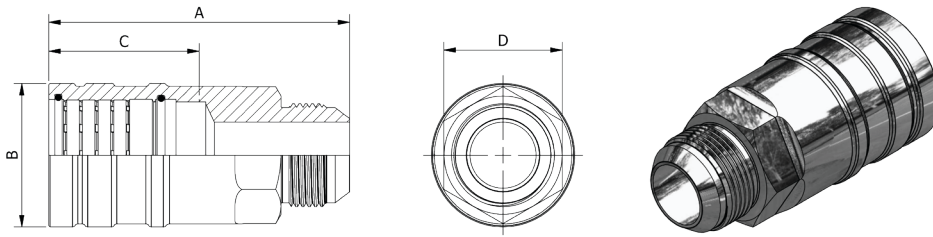

***MATERIAL CODE:**
 K = STAINLESS STEEL
 G = CARBON STEEL
 B = COPPER NICKEL 70/30

ORDER EXAMPLE:
 DM60055G04

JIC 37° Male, OD Tube - DM60055

Size OD	JIC Size	Part Number	Dimensions - Inch (mm)				*Weight K & G lbs (kg)
			A	B	C Insertion Depth	D	
1/4"	04	DM60055*04	1.75 (44.45)	0.39 (9.91)	0.75 (19.05)	0.50 (12.70)	0.04 (0.02)
3/8"	06	DM60055*06	2.06 (52.32)	0.55 (13.97)	0.92 (23.37)	0.63 (16.00)	0.08 (0.04)
1/2"	08	DM60055*08	2.44 (61.98)	0.75 (19.05)	1.09 (27.69)	0.81 (20.57)	0.18 (0.08)
5/8"	10	DM60055*10	2.75 (69.85)	0.93 (23.62)	1.26 (32.00)	0.94 (23.88)	0.28 (0.13)
3/4"	12	DM60055*12	3.38 (85.73)	1.09 (27.69)	1.42 (36.07)	1.13 (28.70)	0.46 (0.21)
1"	16	DM60055*16	3.81 (96.77)	1.41 (35.81)	1.70 (43.18)	1.38 (35.05)	0.79 (0.36)
1-1/4"	20	DM60055*20	4.04 (102.62)	1.73 (43.94)	1.94 (49.28)	1.88 (47.75)	1.31 (0.59)
1-1/2"	24	DM80055*3824	4.63 (118.40)	2.05 (52.07)	2.15 (54.61)	2.00 (50.80)	1.81 (0.82)
2"	32	DM60055*32	5.10 (129.54)	2.58 (65.53)	2.50 (63.50)	3.03 (76.99)	3.31 (1.50)

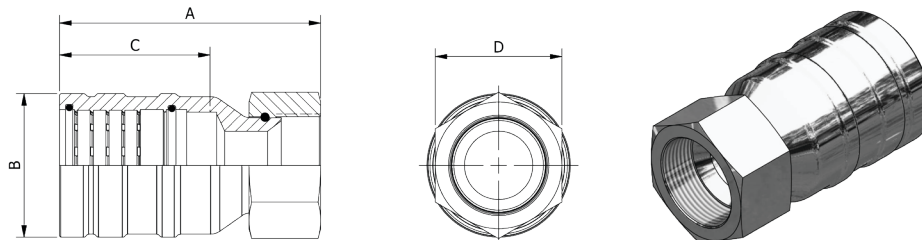

***MATERIAL CODE:**
 K = STAINLESS STEEL
 G = CARBON STEEL
 B = COPPER NICKEL 70/30

ORDER EXAMPLE:
 DM60054G04

JIC 37° Female Swivel, OD Tube - DM60054

Size OD	JIC Size	Part Number	Dimensions - Inch (mm)				*Weight K & G lbs (kg)
			A	B	C Insertion Depth	D	
1/4"	04	DM60054*04	1.66 (42.16)	0.39 (9.91)	0.75 (19.05)	0.56 (14.22)	0.05 (0.02)
3/8"	06	DM60054*06	2.12 (53.85)	0.55 (13.97)	0.92 (23.37)	0.69 (17.53)	0.09 (0.04)
1/2"	08	DM60054*08	2.55 (64.77)	0.75 (19.05)	1.09 (27.69)	0.88 (22.35)	0.19 (0.09)
5/8"	10	DM60054*10	2.60 (66.04)	0.93 (23.62)	1.26 (32.00)	1.00 (25.40)	0.27 (0.12)
3/4"	12	DM60054*12	2.73 (69.34)	1.09 (27.69)	1.42 (36.07)	1.25 (31.75)	0.40 (0.18)
1"	16	DM60054*16	3.17 (80.52)	1.41 (35.81)	1.70 (43.18)	1.50 (38.10)	0.66 (0.30)
1-1/4"	20	DM60054*20	3.61 (91.69)	1.73 (43.94)	1.94 (49.28)	2.00 (50.80)	1.29 (0.59)
1-1/2"	24	DM80054*3824	4.50 (114.30)	2.05 (52.07)	2.15 (54.61)	2.25 (57.15)	2.10 (0.95)
2"	32	DM60054*32	4.95 (125.73)	2.58 (65.53)	2.50 (63.50)	2.88 (73.15)	3.33 (1.51)

3D step models available upon request

DM 60 Series – OD Tube

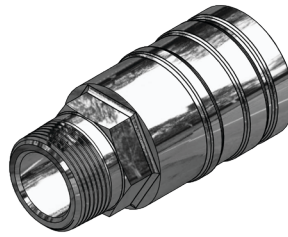
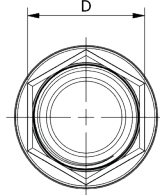
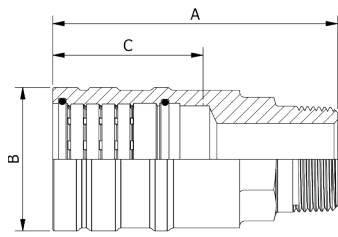

***MATERIAL CODE:**
 K = STAINLESS STEEL
 G = CARBON STEEL
 B = COPPER NICKEL 70/30

ORDER EXAMPLE:
 DM60056G04

NPT Male, OD Tube - DM60056

Size OD	NPT Size	Part Number	Dimensions - Inch (mm)				*Weight K & G lbs (kg)
			A	B	C Insertion Depth	D	
1/4"	1/4"	DM60056*04	1.75 (44.45)	0.39 (9.91)	0.75 (19.05)	0.56 (14.22)	0.06 (0.03)
3/8"	3/8"	DM60056*06	2.06 (52.32)	0.55 (13.97)	0.92 (23.37)	0.75 (19.05)	0.12 (0.05)
1/2"	1/2"	DM60056*08	2.59 (65.79)	0.75 (19.05)	1.09 (27.69)	0.88 (22.35)	0.23 (0.10)
5/8"	1/2"	DM60056*1008	2.75 (69.85)	0.93 (23.62)	1.26 (32.00)	0.75 (19.05)	0.28 (0.13)
3/4"	3/4"	DM60056*12	3.25 (82.55)	1.09 (27.69)	1.42 (36.07)	1.25 (31.75)	0.52 (0.24)
1"	1"	DM60056*16	3.75 (95.25)	1.41 (35.81)	1.70 (43.18)	1.50 (38.10)	0.91 (0.41)
1-1/4"	1-1/4"	DM60056*20	3.88 (98.55)	1.73 (43.94)	1.94 (49.28)	1.75 (44.45)	1.31 (0.59)
1-1/2"	1-1/2"	DM60056*24	4.63 (117.60)	2.05 (52.07)	2.15 (54.61)	2.13 (54.10)	2.00 (0.91)
2"	2"	DM60056*32	4.63 (117.60)	2.58 (65.53)	2.50 (63.50)	2.63 (66.80)	2.62 (1.19)

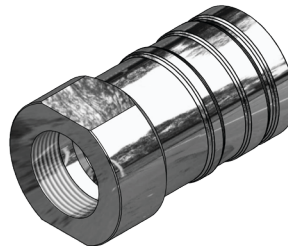
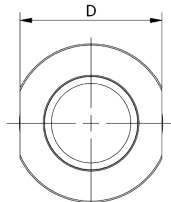
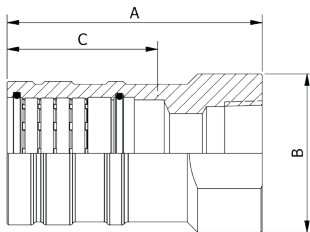

***MATERIAL CODE:**
 K = STAINLESS STEEL
 G = CARBON STEEL
 B = COPPER NICKEL 70/30

ORDER EXAMPLE:
 DM60060G04

NPT Female, OD Tube - DM60060

Size OD	NPT Size	Part Number	Dimensions - Inch (mm)				*Weight K & G lbs (kg)
			A	B	C Insertion Depth	D	
1/4"	1/4"	DM60060*04	1.63 (41.40)	0.39 (9.91)	0.75 (19.05)	0.75 (19.05)	0.09 (0.04)
3/8"	3/8"	DM60060*06	2.00 (50.80)	0.55 (13.97)	0.92 (23.37)	0.88 (22.35)	0.14 (0.06)
1/2"	1/2"	DM60060*08	2.25 (57.15)	0.75 (19.05)	1.09 (27.69)	1.00 (25.40)	0.24 (0.11)
5/8"	1/2"	DM60060*1008	2.50 (63.50)	0.93 (23.62)	1.26 (32.00)	1.00 (25.40)	0.28 (0.13)
3/4"	3/4"	DM60060*12	3.00 (76.20)	1.09 (27.69)	1.42 (36.07)	1.38 (34.93)	0.46 (0.21)
1"	1"	DM60060*16	3.37 (85.60)	1.41 (35.81)	1.70 (43.18)	1.50 (38.10)	0.75 (0.35)
1-1/4"	1-1/4"	DM60060*20	3.63 (92.20)	1.73 (43.94)	1.94 (49.28)	2.00 (50.80)	1.22 (0.55)
1-1/2"	1-1/2"	DM60060*24	3.88 (98.55)	2.05 (52.07)	2.15 (54.61)	2.25 (57.15)	1.74 (0.79)
2"	2"	DM60060*32	4.13 (104.90)	2.58 (65.53)	2.50 (63.50)	2.75 (69.85)	2.34 (1.06)

DM 60 Series – OD Tube

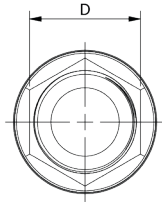
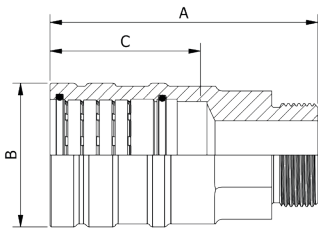

***MATERIAL CODE:**
 K = STAINLESS STEEL
 G = CARBON STEEL
 B = COPPER NICKEL 70/30

ORDER EXAMPLE:
 DM60088G04

SAE Male, OD Tube - DM60088

Size OD	SAE Size	Part Number	Dimensions - Inch (mm)				*Weight K & G lbs (kg)
			A	B	C Insertion Depth	D	
1/4"	04	DM60088*04	1.50 (38.10)	0.39 (9.91)	0.75 (19.05)	0.56 (14.22)	0.04 (0.02)
3/8"	06	DM60088*06	2.00 (50.80)	0.55 (13.97)	0.92 (23.37)	0.69 (17.53)	0.09 (0.04)
1/2"	08	DM60088*08	2.25 (57.15)	0.75 (19.05)	1.09 (27.69)	0.88 (22.35)	0.17 (0.08)
5/8"	10	DM60088*10	2.50 (63.50)	0.93 (23.62)	1.26 (32.00)	1.00 (25.40)	0.26 (0.12)
3/4"	12	DM60088*12	3.25 (82.55)	1.09 (27.69)	1.42 (36.07)	1.25 (31.75)	0.50 (0.23)
1"	16	DM60088*16	3.38 (85.85)	1.41 (35.81)	1.70 (43.18)	1.50 (38.10)	0.76 (0.34)
1-1/4"	20	DM60088*20	3.88 (98.55)	1.73 (43.94)	1.94 (49.28)	1.88 (47.75)	1.31 (0.59)
1-1/2"	24	DM60088*24	4.25 (107.95)	2.06 (52.32)	2.15 (54.61)	2.13 (54.10)	1.90 (0.86)
2"	32	DM60088*32	4.38 (111.25)	2.58 (65.53)	2.50 (63.50)	2.75 (69.85)	2.64 (1.20)

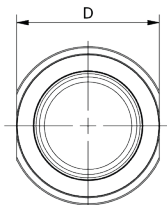
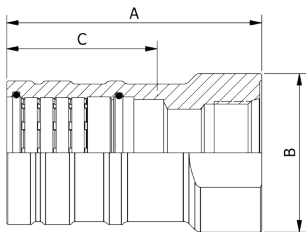

***MATERIAL CODE:**
 K = STAINLESS STEEL
 G = CARBON STEEL
 B = COPPER NICKEL 70/30

ORDER EXAMPLE:
 DM60087G04

SAE Female, OD Tube - DM60087

Size OD	SAE Size	Part Number	Dimensions - Inch (mm)				*Weight K & G lbs (kg)
			A	B	C Insertion Depth	D	
1/4"	04	DM60087*04	1.75 (44.45)	0.88 (22.35)	0.75 (19.05)	0.75 (19.05)	0.11 (0.05)
3/8"	06	DM60087*06	2.00 (50.80)	1.25 (31.75)	0.92 (23.37)	0.88 (22.35)	0.16 (0.07)
1/2"	08	DM60087*08	2.50 (63.50)	1.25 (31.75)	1.09 (27.69)	1.13 (28.70)	0.26 (0.12)
5/8"	10	DM60087*10	2.75 (69.85)	1.50 (38.10)	1.26 (32.00)	1.13 (28.70)	0.45 (0.20)
3/4"	12	DM60087*12	3.38 (85.85)	1.75 (44.45)	1.42 (36.07)	1.50 (38.10)	0.70 (0.32)
1"	16	DM60087*16	3.50 (88.90)	1.98 (50.29)	1.70 (43.18)	1.75 (44.45)	1.00 (0.45)
1-1/4"	20	DM60087*20	3.88 (98.55)	2.50 (63.50)	1.94 (49.28)	2.25 (57.15)	1.73 (0.78)
1-1/2"	24	DM60087*24	4.75 (120.65)	2.75 (69.85)	2.15 (54.61)	2.50 (63.50)	2.83 (1.28)
2"	32	DM60087*32	5.00 (127.00)	3.63 (92.20)	2.50 (63.50)	3.25 (82.55)	4.35 (1.97)

3D step models available upon request

DM 60 Series – OD Tube

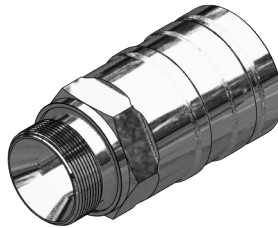
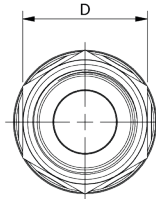
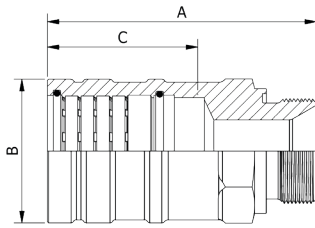

*MATERIAL CODE:
 K = STAINLESS STEEL
 G = CARBON STEEL
 B = COPPER NICKEL 70/30

ORDER EXAMPLE:
 DM60153G04

BSPP Male, OD Tube - DM60153

Size OD	BSPP Size	Part Number	Dimensions - Inch (mm)				*Weight K & G lbs (kg)
			A	B	C Insertion Depth	D	
1/4"	1/4"	DM60153*04	1.63 (41.40)	0.39 (9.91)	0.75 (19.05)	0.75 (19.05)	0.07 (0.03)
3/8"	3/8"	DM60153*06	2.00 (50.80)	0.55 (13.97)	0.92 (23.37)	0.87 (22.10)	0.11 (0.05)
1/2"	1/2"	DM60153*08	2.38 (60.45)	0.75 (19.05)	1.09 (27.69)	1.18 (29.97)	0.24 (0.11)
3/4"	3/4"	DM60153*12	3.25 (82.55)	1.09 (27.69)	1.42 (36.07)	1.42 (36.07)	0.53 (0.24)
1"	1"	DM60153*16	3.50 (88.90)	1.41 (35.81)	1.70 (43.18)	1.81 (45.97)	0.91 (0.41)
1-1/4"	1-1/4"	DM60153*20	3.88 (98.55)	1.73 (43.94)	1.94 (49.28)	1.97 (50.04)	1.41 (0.64)
1-1/2"	1-1/2"	DM80153*3824	4.59 (116.59)	2.05 (52.07)	2.15 (54.61)	2.17 (55.12)	2.14 (0.97)
2"	2"	DM60153*32	4.88 (123.95)	2.58 (65.53)	2.50 (63.50)	2.92 (74.17)	3.16 (1.43)

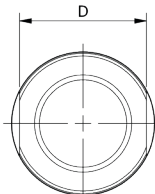
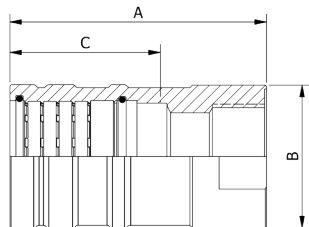

*MATERIAL CODE:
 K = STAINLESS STEEL
 G = CARBON STEEL
 B = COPPER NICKEL 70/30

ORDER EXAMPLE:
 DM60086G04

BSPP Female, OD Tube - DM60086

Size OD	BSPP Size	Part Number	Dimensions - Inch (mm)				*Weight K & G lbs (kg)
			A	B	C Insertion Depth	D	
1/4"	1/4"	DM60086*04	1.69 (42.86)	0.94 (23.03)	0.75 (19.05)	0.79 (20.00)	0.10 (0.05)
3/8"	3/8"	DM60086*06	2.13 (54.10)	1.06 (27.00)	0.92 (23.37)	0.95 (24.00)	0.16 (0.07)
1/2"	1/2"	DM60086*08	2.38 (60.33)	1.25 (31.75)	1.09 (27.69)	1.02 (26.00)	0.25 (0.11)
3/4"	3/4"	DM60086*12	3.13 (79.38)	1.50 (38.10)	1.42 (36.07)	1.26 (32.00)	0.53 (0.24)
1"	1"	DM60086*16	3.50 (88.90)	1.88 (47.63)	1.70 (43.18)	1.65 (42.00)	0.94 (0.43)
1-1/4"	1-1/4"	DM60086*20	3.88 (98.43)	2.25 (57.15)	1.94 (49.28)	2.05 (52.00)	1.49 (0.68)
1-1/2"	1-1/2"	DM80086*3824	4.40 (111.66)	2.75 (69.85)	2.15 (54.61)	2.52 (64.00)	2.60 (1.18)
2"	2"	DM60086*32	4.88 (123.83)	3.50 (88.90)	2.50 (63.50)	2.99 (76.00)	4.22 (1.91)

DM 60 Series – OD Tube

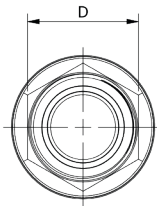
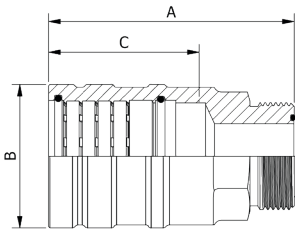

***MATERIAL CODE:**
K = STAINLESS STEEL
G = CARBON STEEL
B = COPPER NICKEL 70/30

ORDER EXAMPLE:
DM60010G04

ORFS Male, OD Tube - DM60010

Size OD	ORFS Size	Part Number	Dimensions - Inch (mm)				*Weight K & G lbs (kg)
			A	B	C Insertion Depth	D	
1/4"	04	DM60010*04	1.63 (41.40)	0.39 (9.91)	0.75 (19.05)	0.63 (16.00)	0.07 (0.03)
3/8"	06	DM60010*06	2.00 (50.80)	0.55 (13.97)	0.92 (23.37)	0.75 (19.05)	0.12 (0.05)
1/2"	08	DM60010*08	2.38 (60.45)	0.75 (19.05)	1.09 (27.69)	0.88 (22.35)	0.25 (0.13)
5/8"	10	DM60010*10	2.63 (66.80)	0.93 (23.62)	1.26 (32.00)	1.13 (28.70)	0.34 (0.15)
3/4"	12	DM60010*12	3.25 (82.55)	1.09 (27.69)	1.42 (36.07)	1.25 (31.75)	0.48 (0.22)
1"	16	DM60010*16	3.50 (88.90)	1.41 (35.81)	1.70 (43.18)	1.50 (38.10)	0.82 (0.37)
1-1/4"	20	DM60010*20	3.75 (95.25)	1.73 (43.94)	1.94 (49.28)	1.75 (44.45)	1.20 (0.54)
1-1/2"	24	DM60010*24	4.13 (104.90)	2.05 (52.07)	2.15 (54.61)	2.13 (54.10)	1.80 (0.82)

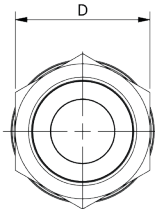
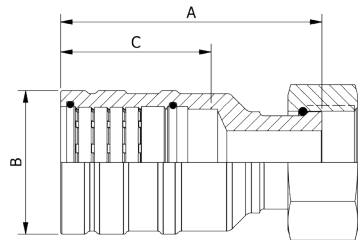

***MATERIAL CODE:**
K = STAINLESS STEEL
G = CARBON STEEL
B = COPPER NICKEL 70/30

ORDER EXAMPLE:
DM60020G04

ORFS Female Swivel, OD Tube - DM60020

Size OD	ORFS Size	Part Number	Dimensions - Inch (mm)				*Weight K & G lbs (kg)
			A	B	C Insertion Depth	D	
1/4"	04	DM60020*04	1.75 (44.45)	0.39 (9.91)	0.75 (19.05)	0.67 (17.02)	0.05 (0.02)
3/8"	06	DM60020*06	2.13 (54.10)	0.55 (13.97)	0.92 (23.37)	0.86 (21.84)	0.15 (0.07)
1/2"	08	DM60020*08	2.25 (57.15)	0.75 (19.05)	1.09 (27.69)	0.94 (23.88)	0.20 (0.09)
5/8"	10	DM60020*10	2.50 (63.50)	0.93 (23.62)	1.26 (32.00)	1.17 (29.72)	0.33 (0.15)
3/4"	12	DM60020*12	3.25 (82.55)	1.09 (27.69)	1.42 (36.07)	1.63 (41.40)	0.79 (0.36)
1"	16	DM60020*16	3.50 (88.90)	1.41 (35.81)	1.70 (43.18)	1.75 (44.45)	1.04 (0.47)
1-1/4"	20	DM60020*20	3.63 (92.20)	1.73 (43.94)	1.94 (49.28)	2.13 (54.10)	1.63 (0.74)
1-1/2"	24	DM60020*24	4.00 (101.60)	2.05 (52.07)	2.15 (54.61)	2.38 (60.45)	2.25 (1.02)

3D step models available upon request

DM 60 Series – OD Tube

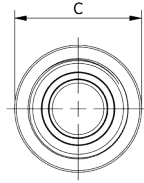
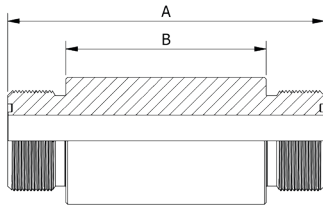

***MATERIAL CODE:**
 K = STAINLESS STEEL
 G = CARBON STEEL
 B = COPPER NICKEL 70/30

ORDER EXAMPLE:
 DM60089G08

Weldable Bulkhead, OD Tube - DM60089

Size OD	ORFS Size	Part Number	Dimensions - Inch (mm)			Thread Details	*Weight K & G lbs (kg)
			A	B	C		
1/2"	08	DM60089*08	3.00 (76.20)	1.99 (50.55)	1.00 (25.40)	13/16"-16UNF-2A	0.49 (0.22)
3/4"	12	DM60089*12	3.75 (95.25)	2.37 (60.20)	1.50 (38.10)	1-3/16"-12UNF-2A	1.31 (0.59)
1"	16	DM60089*16	3.75 (95.25)	2.37 (60.20)	1.75 (44.45)	1-7/16"-12UNF-2A	1.70 (0.77)
1-1/4"	20	DM60089*20	4.00 (101.60)	2.62 (66.55)	2.00 (50.80)	1-11/16"-12UNF-2A	2.28 (1.03)
1-1/2"	24	DM60089*24	4.25 (107.95)	2.87 (72.90)	2.38 (60.45)	2"-12UNF-2A	2.89 (1.31)

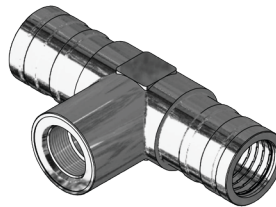
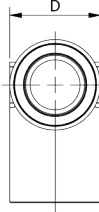
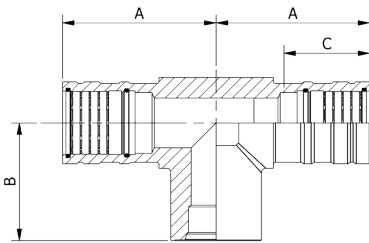

***MATERIAL CODE:**
 K = STAINLESS STEEL
 G = CARBON STEEL
 B = COPPER NICKEL 70/30

ORDER EXAMPLE:
 DM60171G0804

Other configurations available.
 Contact factory for details.

SAE Female Branch Tee, OD Tube - DM60171

Size OD	SAE Size	Part Number	Dimensions - Inch (mm)				*Weight K & G lbs (kg)
			A	B	C Insertion Depth	D	
1/2"	04	DM60171*0804	1.75 (44.45)	0.75 (19.05)	1.09 (27.69)	0.86 (21.84)	0.31 (0.14)
5/8"	06	DM60171*1006	2.00 (50.80)	1.00 (25.40)	1.26 (32.00)	1.06 (26.92)	0.57 (0.26)
3/4"	08	DM60171*1208	2.68 (68.07)	1.25 (31.75)	1.42 (36.07)	1.30 (33.02)	1.04 (0.47)
1"	10	DM60171*1610	3.03 (76.96)	1.50 (38.10)	1.70 (43.18)	1.58 (40.13)	1.86 (0.84)
1-1/4"	12	DM60171*2012	3.40 (86.36)	1.75 (44.45)	1.94 (49.28)	1.97 (50.04)	3.20 (1.46)
1-1/2"	16	DM60171*2416	4.25 (107.95)	2.00 (50.80)	2.20 (55.88)	2.50 (63.50)	6.23 (2.83)
2"	20	DM60171*3220	4.54 (115.32)	2.25 (57.15)	2.50 (63.50)	2.81 (71.37)	8.06 (3.66)

DM 60 Series – OD Tube

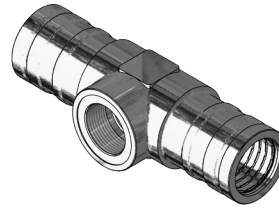
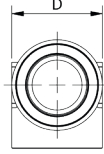
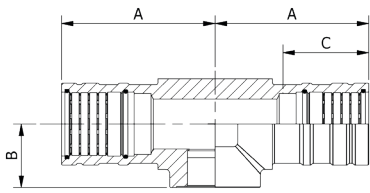

***MATERIAL CODE:**
 K = STAINLESS STEEL
 G = CARBON STEEL
 B = COPPER NICKEL 70/30

ORDER EXAMPLE:
 DM60172G0804

Other configurations available.
 Contact factory for details.

BSPP Female Branch Tee, OD Tube - DM60172

Size OD	BSPP Size	Part Number	Dimensions - Inch (mm)				*Weight K & G lbs (kg)
			A	B	C Insertion Depth	D	
1/2"	1/4"	DM60172*0804	1.75 (44.45)	0.75 (19.05)	1.09 (27.69)	0.86 (21.84)	0.30 (0.14)
3/4"	1/2"	DM60172*1208	2.68 (68.07)	1.25 (31.75)	1.42 (36.07)	1.30 (33.02)	1.06 (0.48)
1"	3/4"	DM60172*1612	3.03 (76.96)	1.50 (38.10)	1.70 (43.18)	1.58 (40.13)	1.78 (0.81)
1-1/4"	1"	DM60172*2016	3.37 (85.60)	1.75 (44.45)	1.94 (49.28)	1.97 (50.04)	3.09 (1.40)
1-1/2"	1-1/4"	DM80172*3820	4.25 (107.95)	1.63 (41.28)	2.15 (54.61)	2.50 (63.50)	5.53 (2.51)
2"	1-1/2"	DM60172*3224	4.54 (115.32)	2.25 (57.15)	2.50 (63.50)	2.69 (68.33)	7.78 (3.53)

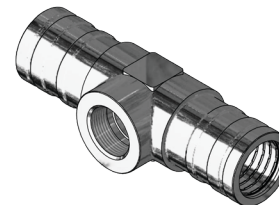
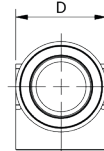
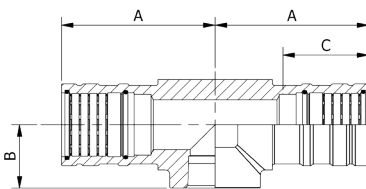

***MATERIAL CODE:**
 K = STAINLESS STEEL
 G = CARBON STEEL
 B = COPPER NICKEL 70/30

ORDER EXAMPLE:
 DM60173G0806

Other configurations available.
 Contact factory for details.













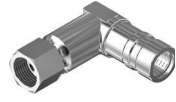









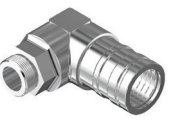





NPT Female Branch Tee, OD Tube - DM60173

Size OD	NPT Size	Part Number	Dimensions - Inch (mm)				*Weight K & G lbs (kg)
			A	B	C Insertion Depth	D	
1/2"	3/8"	DM60173*0806	1.75 (44.45)	0.75 (19.05)	1.09 (27.69)	0.86 (21.84)	0.29 (0.13)
5/8"	1/2"	DM60173*1008	2.00 (50.80)	1.00 (25.40)	1.26 (32.00)	1.06 (26.92)	0.53 (0.24)
3/4"	1/2"	DM60173*1208	2.68 (68.07)	1.25 (31.75)	1.42 (36.07)	1.30 (33.02)	1.05 (0.48)
1"	3/4"	DM60173*1612	3.03 (76.96)	1.50 (38.10)	1.70 (43.18)	1.58 (40.13)	1.82 (0.83)
1-1/4"	1"	DM60173*2016	3.40 (86.36)	1.75 (44.45)	1.94 (49.28)	1.97 (50.04)	3.19 (1.45)
1-1/2"	1-1/4"	DM60173*2420	4.25 (107.95)	2.00 (50.80)	2.20 (55.88)	2.50 (63.50)	6.12 (2.76)
2"	1-1/2"	DM60173*3224	4.54 (115.32)	2.25 (57.15)	2.50 (63.50)	2.81 (71.37)	7.93 (3.60)

Specialty Fitting Configuration Guide

DM 60 Series - OD Tube

1/4" to 2"

					
JIC 37° 90° Elbow Male DM60355	JIC 37° Branch Tee Male DM60177	JIC 37° Run Tee Male DM60178	JIC 37° 90° Elbow Female Swivel DM60354	JIC 37° Branch Tee Female Swivel DM60170	NPT 90° Elbow Male DM60057
					
NPT Branch Tee Male DM60176	NPT Run Tee Male DM60181	NPT 90° Elbow Female DM60061	ORFS 90° Elbow Male DM60011	ORFS Branch Tee Male DM60013	ORFS Run Tee Male DM60014
					
ORFS 90° Elbow Female Swivel DM60021	ORFS Branch Tee Female Swivel DM60023	SAE 90° Elbow Male DM60105	SAE Branch Tee Male DM60174	SAE Run Tee Male DM60179	SAE 90° Elbow Female DM60387
					
BSPP 90° Elbow Male DM60168	BSPP Branch Tee Male DM60175	BSPP Run Tee Male DM60180	BSPP 90° Elbow Female DM60169	BSPP Cross Fitting with 2 Ports DM60221	BSPP Cross Fitting with 4 Ports DM60241
					
Flange - ANSI #900 DM60025	Flange - ANSI #1500 DM60026	Compact Elbow x Code 61 Flange DM60231	Compact Elbow x Code 62 Flange DM60232	90° PYPLOK® x SAE Code 61 Flange DM60391	90° PYPLOK® x SAE Code 62 Flange DM60392

Specialty Fitting Configuration Guide

DM 60 Series - OD Tube

1/4" to 2"



NPS to OD Tube Reducer
DM20501



CPV Female
DM60040



CPV Male Union
DM60041



Extra Long Coupling
DM60301



Tailpiece Gaugeline Adapter
DM60050

Introduction

Technical Information

DM 20 – NPS Pipe

DM 60 – OD Tube

DM 80 – Metric & JIS Tube

DP-40N – NPS Low Pressure

DP-40M – Metric Low Pressure

PYPLOK® Tooling

Installation Procedures

Appendix

General Characteristics

DM 80 Series - Metric Tube

Fitting Material Specifications

K = Stainless Steel
 *G = Carbon Steel
 B = Copper Nickel 70/30
 C = Copper Nickel 90/10
 D = Duplex
 Z = Super Duplex

Material Specification

ASTM-A479/A182-316
 ASTM-A105/A350 LF2
 MIL-C71500
 MIL-C70600
 ASTM-A479/A182-UNS31803
 ASTM-A479/A182-UNS32750

*60mm Carbon Steel PYPLOK® material specification is AISI/SAE-4140 unless otherwise noted.

O-Ring Material Specifications

VITON (Brown Colour)
 EPDM (Black Colour)

O-Ring Temperature Limits

-15°F to 400°F (-26°C to 205°C)
 -60°F to 400°F (-51°C to 205°C)

For seal compatibility and selection for each system consult factory. Other seal materials for specific applications of compatibility and temperature are available upon request.

Ordering Information

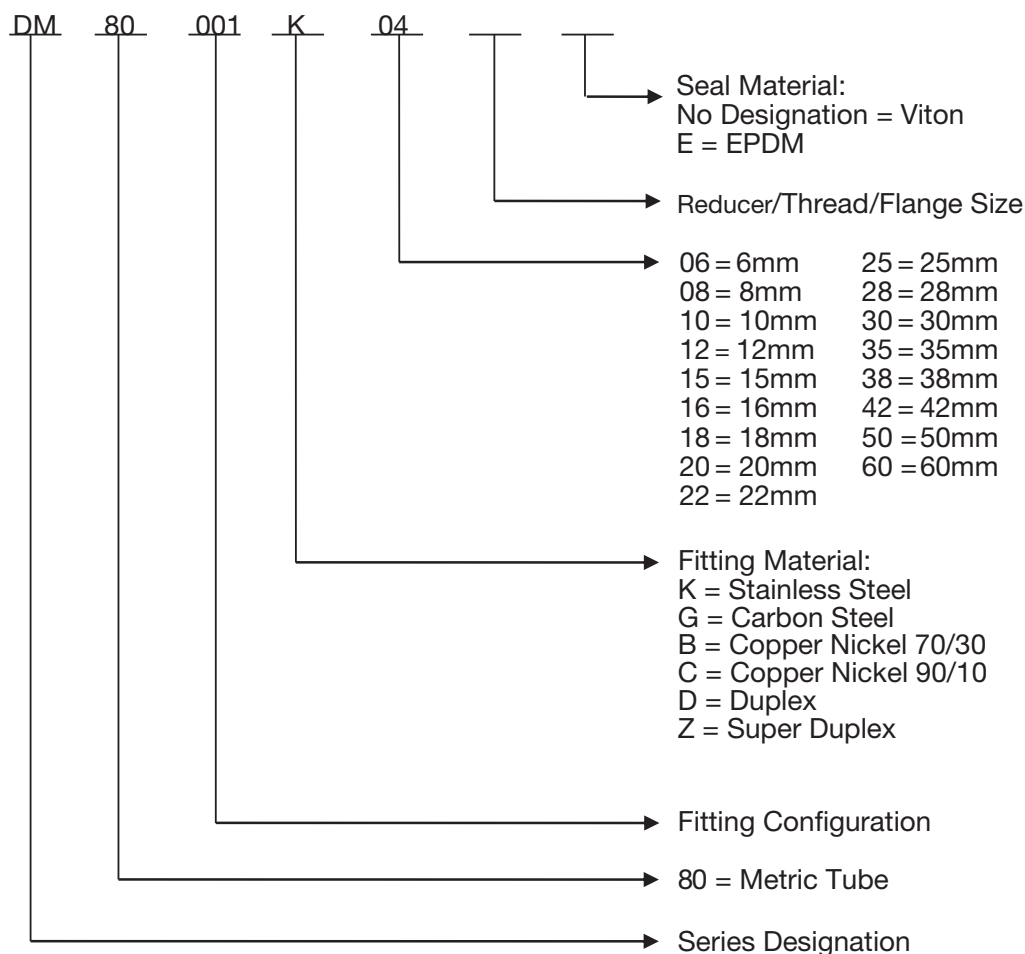

System design and safe application is the responsibility of the end-user. Consideration must be taken to confirm proper fitting selection is made to ensure proper compatibility, function and operation of the fitting within the piping system. The technical and performance information such as weights, dimensions and ratings in this catalogue supersede all previous published data. Tube-Mac® reserves the right to change technical data and product dimension, ratings and other aspects without notice.

Standard Fitting Configuration Guide

DM 80 Series - Metric Tube

6mm to 60mm

					
Coupling DM80001 Page E3	Coupling with Inner Stop DM80002 Page E4	90° Elbow DM80003 Page E5	45° Elbow DM80017 Page E6	Tee DM80004 Page E7	Reducing Tee DM80104 Page E8
					
Reducer DM80101 Page E9	End Cap DM80085 Page E10	Flange - PN16 DM80028 Page E11	Flange - PN40 DM80029 Page E11	SAE Flange Body DM80090 Page E12	ISO 6162-1 Flange DM80091 Page E13
					
ISO 6162-2 Flange DM80092 Page E13	ISO 6162-1 Tapped Flange DM80095 Page E14	ISO 6162-2 Tapped Flange DM80096 Page E14	JIC 37° Male DM80055 Page E15	JIC 37° Female Swivel DM80054 Page E15	BSPP Male DM80153 Page E16
					
BSPP Female DM80086 Page E17	DIN 24° Male DM80066 Page E18	DIN 24° Female Swivel DM80068 Page E19	Weldable Bulkhead DM80089 Page E20	BSPP Female Branch Tee DM80172 Page E21	Tee with BSPP Branch DM80211 Page E22
					
BSPP Cross Fitting with 2 Ports DM80221 Page E23	BSPP Cross Fitting with 4 Ports DM80241 Page E24				

DM 80 Series - Metric Tube

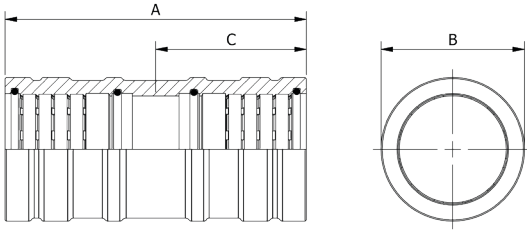

***MATERIAL CODE:**
K = STAINLESS STEEL
G = CARBON STEEL
B = COPPER NICKEL 70/30

ORDER EXAMPLE:
DM80001G06

Coupling, Metric - DM80001

Size OD (mm)	Part Number	Dimensions - mm (Inch)			*Weight K & G kg (lbs)
		A	B	C Insertion Depth	
6	DM80001*06	33.00 (1.30)	9.80 (0.39)	16.51 (0.65)	0.01 (0.02)
8	DM80001*08	38.61 (1.52)	12.19 (0.48)	19.30 (0.76)	0.02 (0.03)
10	DM80001*10	48.30 (1.90)	15.09 (0.59)	24.13 (0.95)	0.03 (0.06)
12	DM80001*12	54.00 (2.13)	18.59 (0.73)	27.00 (1.06)	0.05 (0.10)
15	DM80001*15	64.01 (2.52)	23.70 (0.93)	32.00 (1.26)	0.10 (0.23)
16	DM80001*16	64.01 (2.52)	23.70 (0.93)	32.00 (1.26)	0.09 (0.19)
18	DM80001*18	69.85 (2.75)	25.15 (0.99)	35.05 (1.38)	0.09 (0.20)
20	DM80001*20	74.17 (2.91)	28.70 (1.13)	37.08 (1.46)	0.15 (0.32)
22	DM80001*22	76.20 (3.00)	30.48 (1.20)	38.10 (1.50)	0.15 (0.33)
25	DM80001*25	84.07 (3.31)	35.31 (1.39)	41.91 (1.65)	0.24 (0.53)
28	DM80001*28	88.90 (3.50)	37.59 (1.48)	44.45 (1.75)	0.24 (0.54)
30	DM80001*30	93.98 (3.70)	41.91 (1.65)	46.99 (1.85)	0.39 (0.85)
35	DM80001*35	101.60 (4.00)	46.23 (1.82)	50.80 (2.00)	0.41 (0.91)
38	DM80001*38	108.97 (4.29)	52.07 (2.05)	54.61 (2.15)	0.71 (1.57)
42	DM20001*20	120.65 (4.75)	57.40 (2.26)	60.45 (2.38)	0.89 (1.96)
50	DM80001*50	127.00 (5.00)	65.53 (2.58)	63.50 (2.50)	1.12 (2.46)
**60K	DM20001K32	177.80 (7.00)	77.22 (3.04)	88.90 (3.50)	2.00 (4.40)
60G	DM80001G60	177.80 (7.00)	77.22 (3.04)	88.90 (3.50)	2.00 (4.40)

**2" DM 20 Series Stainless Steel fittings are also used for 60mm Stainless Steel applications.

DM 80 Series - Metric Tube

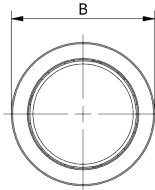
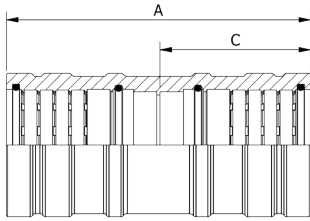

***MATERIAL CODE:**
K = STAINLESS STEEL
G = CARBON STEEL
B = COPPER NICKEL 70/30

ORDER EXAMPLE:
DM80002G06

Coupling with Inner Stop, Metric - DM80002					
Size OD (mm)	Part Number	Dimensions - mm (Inch)			*Weight K & G kg (lbs)
		A	B	C Insertion Depth	
6	DM80002*06	34.29 (1.35)	9.80 (0.39)	16.51 (0.65)	0.01 (0.02)
8	DM80002*08	39.88 (1.57)	12.19 (0.48)	19.30 (0.76)	0.01 (0.03)
10	DM80002*10	49.53 (1.95)	15.09 (0.59)	24.13 (0.95)	0.06 (0.03)
12	DM80002*12	55.37 (2.18)	18.59 (0.73)	26.92 (1.06)	0.05 (0.10)
15	DM80002*15	65.28 (2.57)	23.70 (0.93)	32.00 (1.26)	0.10 (0.23)
16	DM80002*16	65.28 (2.57)	23.70 (0.93)	32.00 (1.26)	0.09 (0.20)
18	DM80002*18	71.12 (2.80)	25.15 (0.99)	35.05 (1.38)	0.10 (0.22)
20	DM80002*20	75.44 (2.97)	28.70 (1.13)	37.08 (1.46)	0.15 (0.32)
22	DM80002*22	77.47 (3.05)	30.48 (1.20)	38.10 (1.50)	0.15 (0.33)
25	DM80002*25	85.34 (3.36)	35.31 (1.39)	41.91 (1.65)	0.24 (0.54)
28	DM80002*28	90.17 (3.55)	37.59 (1.48)	44.45 (1.75)	0.25 (0.55)
30	DM80002*30	95.25 (3.75)	41.91 (1.65)	46.99 (1.85)	0.39 (0.85)
35	DM80002*35	102.87 (4.05)	46.23 (1.82)	50.80 (2.00)	0.41 (0.91)
38	DM80002*38	110.24 (4.34)	52.07 (2.05)	54.61 (2.15)	0.71 (1.57)
42	DM20002*20	121.92 (4.80)	57.40 (2.26)	60.45 (2.38)	0.89 (1.96)
50	DM80002*50	128.27 (5.05)	65.53 (2.58)	63.50 (2.50)	0.89 (1.96)
**60K	DM20002K32	179.07 (7.05)	77.22 (3.04)	88.90 (3.50)	2.00 (4.40)
60G	DM80002G60	179.07 (7.05)	77.22 (3.04)	88.90 (3.50)	2.00 (4.40)

**2" DM 20 Series Stainless Steel fittings are also used for 60mm Stainless Steel applications.

DM 80 Series - Metric Tube

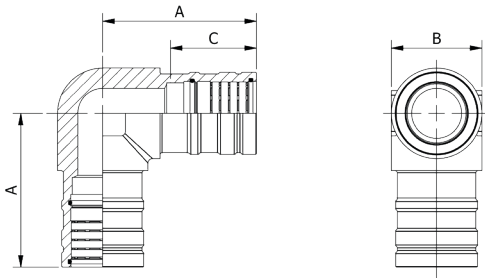

***MATERIAL CODE:**
K = STAINLESS STEEL
G = CARBON STEEL
B = COPPER NICKEL 70/30

ORDER EXAMPLE:
DM80003G06

90° Elbow, Metric - DM80003

Size OD (mm)	Part Number	Dimensions - mm (Inch)			*Weight K & G kg (lbs)
		A	B	C Insertion Depth	
6	DM80003*06	27.94 (1.10)	11.81 (0.47)	16.51 (0.65)	0.02 (0.04)
8	DM80003*08	35.31 (1.39)	16.00 (0.63)	19.30 (0.76)	0.04 (0.08)
10	DM80003*10	42.67 (1.68)	21.84 (0.86)	24.13 (0.95)	0.08 (0.18)
12	DM80003*12	45.29 (1.78)	21.84 (0.86)	26.92 (1.06)	0.09 (0.20)
15	DM80003*15	52.07 (2.05)	26.92 (1.06)	32.00 (1.26)	0.18 (0.40)
16	DM80003*16	52.07 (2.05)	26.92 (1.06)	32.00 (1.26)	0.20 (0.43)
18	DM80003*18	52.07 (2.05)	26.92 (1.06)	35.05 (1.38)	0.21 (0.46)
20	DM80003*20	73.15 (2.88)	33.02 (1.30)	37.08 (1.46)	0.36 (0.80)
22	DM80003*22	73.15 (2.88)	33.02 (1.30)	38.10 (1.50)	0.47 (1.04)
25	DM80003*25	76.96 (3.03)	40.13 (1.58)	41.91 (1.65)	0.58 (1.27)
28	DM80003*28	76.96 (3.03)	40.13 (1.58)	44.45 (1.75)	0.66 (1.45)
30	DM80003*30	85.60 (3.37)	50.04 (1.97)	46.99 (1.85)	1.13 (2.50)
35	DM80003*35	85.60 (3.37)	50.04 (1.97)	50.80 (2.00)	1.18 (2.60)
38	DM80003*38	107.95 (4.25)	63.50 (2.50)	54.61 (2.15)	2.46 (5.42)
42	DM20003*20	107.95 (4.25)	63.50 (2.50)	60.45 (2.38)	2.70 (5.95)
50	DM80003*50	115.32 (4.54)	71.37 (2.81)	63.50 (2.50)	3.18 (7.00)
**60K	DM20003K32	138.43 (5.45)	82.55 (3.25)	88.90 (3.50)	4.40 (9.70)
60G	DM80003G60	138.43 (5.45)	82.55 (3.25)	88.90 (3.50)	4.40 (9.70)

**2" DM 20 Series Stainless Steel fittings are also used for 60mm Stainless Steel applications.

DM 80 Series - Metric Tube

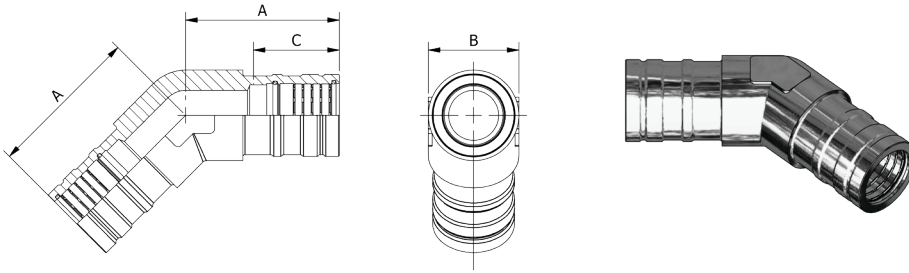

***MATERIAL CODE:**
 K = STAINLESS STEEL
 G = CARBON STEEL
 B = COPPER NICKEL 70/30

ORDER EXAMPLE:
 DM80017G06

45° Elbow, Metric - DM80017

Size OD (mm)	Part Number	Dimensions - mm (Inch)			*Weight K & G kg (lbs)
		A	B	C Insertion Depth	
6	DM80017*06	27.94 (1.10)	11.81 (0.47)	16.51 (0.65)	0.02 (0.05)
8	DM80017*08	35.31 (1.39)	16.00 (0.63)	19.30 (0.76)	0.05 (0.10)
10	DM80017*10	42.67 (1.68)	21.84 (0.86)	24.13 (0.95)	0.09 (0.19)
12	DM80017*12	45.21 (1.78)	21.84 (0.86)	26.92 (1.06)	0.13 (0.29)
15	DM80017*15	52.07 (2.05)	26.92 (1.06)	32.00 (1.26)	0.23 (0.50)
16	DM80017*16	52.07 (2.05)	26.92 (1.06)	32.00 (1.26)	0.23 (0.50)
18	DM80017*18	52.07 (2.05)	26.92 (1.06)	35.05 (1.38)	0.21 (0.47)
20	DM80017*20	73.15 (2.88)	33.02 (1.30)	37.08 (1.46)	0.46 (1.02)
22	DM80017*22	73.15 (2.88)	33.02 (1.30)	38.10 (1.50)	0.48 (1.05)
25	DM80017*25	76.96 (3.03)	40.13 (1.58)	41.91 (1.65)	0.72 (1.59)
28	DM80017*28	76.96 (3.03)	40.13 (1.58)	44.45 (1.75)	0.68 (1.50)
30	DM80017*30	85.60 (3.37)	50.04 (1.97)	46.99 (1.85)	1.22 (2.68)
35	DM80017*35	85.60 (3.37)	50.04 (1.97)	50.80 (2.00)	1.16 (2.55)
38	DM80017*38	107.95 (4.25)	63.50 (2.50)	54.61 (2.15)	2.30 (5.08)
42	DM20017*20	107.95 (4.25)	63.50 (2.50)	60.45 (2.38)	2.54 (5.60)
50	DM80017*50	115.32 (4.54)	71.37 (2.81)	63.50 (2.50)	3.30 (7.27)
**60	DM20017K32	138.43 (5.45)	82.55 (3.25)	88.90 (3.50)	4.35 (9.60)

**Only available in Stainless Steel.

DM 80 Series - Metric Tube

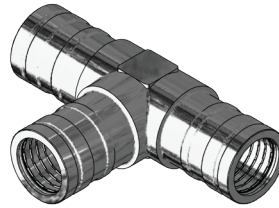
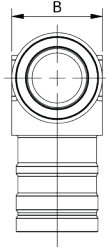
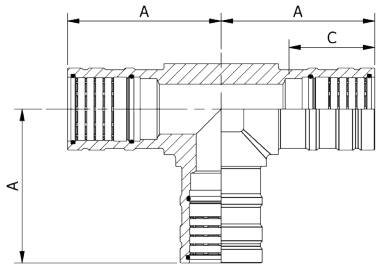

***MATERIAL CODE:**
 K = STAINLESS STEEL
 G = CARBON STEEL
 B = COPPER NICKEL 70/30

ORDER EXAMPLE:
 DM80004G06

Tee, Metric - DM80004					
Size OD (mm)	Part Number	Dimensions - mm (Inch)			*Weight K & G kg (lbs)
		A	B	C Insertion Depth	
6	DM80004*06	27.94 (1.10)	11.81 (0.47)	16.51 (0.65)	0.03 (0.06)
8	DM80004*08	35.31 (1.39)	16.00 (0.63)	19.30 (0.76)	0.06 (0.13)
10	DM80004*10	42.67 (1.68)	21.84 (0.86)	24.13 (0.95)	0.09 (0.20)
12	DM80004*12	45.21 (1.78)	21.84 (0.86)	26.92 (1.06)	0.15 (0.34)
15	DM80004*15	52.07 (2.05)	26.92 (1.06)	32.00 (1.26)	0.27 (0.59)
16	DM80004*16	52.07 (2.05)	26.92 (1.06)	32.00 (1.26)	0.29 (0.65)
18	DM80004*18	52.07 (2.05)	26.92 (1.06)	35.05 (1.38)	0.27 (0.60)
20	DM80004*20	73.15 (2.88)	33.02 (1.30)	37.08 (1.46)	0.59 (1.30)
22	DM80004*22	73.15 (2.88)	33.02 (1.30)	38.10 (1.50)	0.64 (1.42)
25	DM80004*25	76.96 (3.03)	40.13 (1.58)	41.91 (1.65)	0.91 (2.01)
28	DM80004*28	76.96 (3.03)	40.13 (1.58)	44.45 (1.75)	0.89 (1.96)
30	DM80004*30	85.60 (3.37)	50.04 (1.97)	46.99 (1.85)	1.46 (3.22)
35	DM80004*35	85.60 (3.37)	50.04 (1.97)	50.80 (2.00)	1.46 (3.22)
38	DM80004*38	107.95 (4.25)	63.50 (2.50)	54.61 (2.15)	3.00 (6.61)
42	DM20004*20	107.95 (4.25)	63.50 (2.50)	60.45 (2.38)	3.22 (7.10)
50	DM80004*50	115.32 (4.54)	71.37 (2.81)	63.50 (2.50)	4.09 (9.02)
**60K	DM20004K32	138.43 (5.45)	71.37 (2.81)	88.90 (3.50)	5.55 (12.20)
60G	DM80004G60	138.43 (5.45)	82.55 (3.25)	88.90 (3.50)	5.55 (12.20)

**2" DM 20 Series Stainless Steel fittings are also used for 60mm Stainless Steel applications.

DM 80 Series - Metric Tube

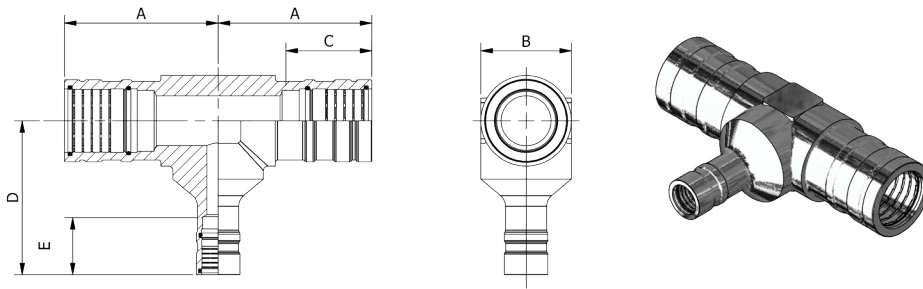

*MATERIAL CODE:

K = STAINLESS STEEL

G = CARBON STEEL

B = COPPER NICKEL 70/30

ORDER EXAMPLE:

DM80104G0806

Other configurations available.

Contact factory for details.

Reducing Tee, Metric - DM80104

Run Size OD (mm)	Branch Size OD (mm)	Part Number	Dimensions - mm (Inch)					*Weight K & G kg (lbs)
			A	B	C Insertion Depth	D	E Insertion Depth	
8	6	DM80104*0806	35.31 (1.39)	16.00 (0.63)	19.30 (0.76)	31.75 (1.25)	16.51 (0.65)	0.06 (0.13)
10	8	DM80104*1008	42.67 (1.68)	21.84 (0.86)	24.13 (0.95)	41.91 (1.65)	19.30 (0.76)	0.11 (0.24)
12	10	DM80104*1210	42.21 (1.78)	21.84 (0.86)	26.92 (1.06)	46.23 (0.82)	24.13 (0.95)	0.17 (0.37)
15	10	DM80104*1510	52.07 (2.05)	26.92 (1.06)	32.00 (1.26)	47.50 (1.87)	24.13 (0.95)	0.28 (0.61)
15	12	DM80104*1512	52.07 (2.05)	26.92 (1.06)	32.00 (1.26)	49.53 (1.95)	26.92 (1.06)	0.29 (0.63)
16	10	DM80104*1610	52.07 (2.05)	26.92 (1.06)	32.00 (1.26)	47.50 (1.87)	24.13 (0.95)	0.27 (0.59)
16	12	DM80104*1612	52.07 (2.05)	26.92 (1.06)	32.00 (1.26)	49.28 (1.94)	26.92 (1.06)	0.26 (0.57)
18	12	DM80104*1812	52.07 (2.05)	26.92 (1.06)	35.05 (1.38)	46.48 (1.83)	26.92 (1.06)	0.25 (0.56)
18	15	DM80104*1815	52.07 (2.05)	26.92 (1.06)	35.05 (1.38)	50.80 (2.00)	32.00 (1.26)	0.29 (0.63)
20	12	DM80104*2012	73.15 (2.88)	33.02 (1.30)	37.08 (1.46)	52.83 (2.08)	26.92 (1.06)	0.54 (1.19)
20	16	DM80104*2016	73.15 (2.88)	33.02 (1.30)	37.08 (1.46)	65.28 (2.57)	32.00 (1.26)	0.56 (1.24)
22	15	DM80104*2215	73.15 (2.88)	33.02 (1.30)	38.10 (1.50)	57.40 (2.26)	32.00 (1.26)	0.54 (1.19)
22	18	DM80104*2218	73.15 (2.88)	33.02 (1.30)	38.10 (1.50)	63.50 (2.50)	38.10 (1.50)	0.54 (1.20)
25	16	DM80104*2516	76.96 (3.03)	40.13 (1.58)	41.91 (1.65)	72.14 (2.84)	32.00 (1.26)	0.91 (2.00)
25	20	DM80104*2520	76.96 (3.03)	40.13 (1.58)	41.91 (1.65)	79.76 (3.14)	37.08 (1.46)	1.09 (2.40)
28	18	DM80104*2818	76.96 (3.03)	40.13 (1.58)	44.45 (1.75)	76.20 (3.00)	35.05 (1.38)	0.86 (1.90)
28	22	DM80104*2822	76.96 (3.03)	40.13 (1.58)	44.45 (1.75)	79.76 (3.14)	38.10 (1.50)	0.87 (1.91)
30	20	DM80104*3020	85.60 (3.37)	50.04 (1.97)	46.99 (1.85)	79.76 (3.14)	37.08 (1.46)	1.44 (3.18)
30	25	DM80104*3025	85.60 (3.37)	50.04 (1.97)	46.99 (1.85)	85.60 (3.37)	41.91 (1.65)	1.51 (3.22)
35	20	DM80104*3520	85.60 (3.37)	50.04 (1.97)	50.80 (2.00)	85.60 (3.37)	37.08 (1.46)	1.41 (3.10)
35	22	DM80104*3522	85.60 (3.37)	50.04 (1.97)	50.80 (2.00)	85.60 (3.37)	38.10 (1.50)	1.49 (3.28)
35	28	DM80104*3528	85.60 (3.37)	50.04 (1.97)	50.80 (2.00)	85.60 (3.37)	44.45 (1.75)	1.56 (3.43)
38	25	DM80104*3825	107.95 (4.25)	63.50 (2.50)	54.61 (2.15)	107.95 (4.25)	41.91 (1.65)	3.06 (6.75)
38	30	DM80104*3830	107.95 (4.25)	63.50 (2.50)	54.61 (2.15)	107.95 (4.25)	46.99 (1.85)	3.04 (6.70)
42	35	DM80104*4235	107.95 (4.25)	63.50 (2.50)	60.45 (2.38)	107.95 (4.25)	50.80 (2.00)	3.19 (7.04)
42	38	DM80104*4238	107.95 (4.25)	63.50 (2.50)	60.45 (2.38)	107.95 (4.25)	54.61 (2.15)	3.67 (8.08)
50	38	DM80104*5038	115.32 (4.54)	71.37 (2.81)	63.50 (2.50)	115.32 (4.54)	54.61 (2.15)	4.11 (9.06)
50	42	DM80104*5042	115.32 (4.54)	71.37 (2.81)	63.50 (2.50)	115.32 (4.54)	60.45 (2.38)	3.98 (8.78)
60	38	DM80104*6038	138.43 (5.45)	82.55 (3.25)	88.90 (3.50)	138.43 (5.45)	54.16 (2.15)	6.21 (13.69)
60	50	DM80104*6050	138.43 (5.45)	82.55 (3.25)	88.90 (3.50)	138.43 (5.45)	63.50 (2.50)	6.23 (13.73)

3D step models available upon request

DM 80 Series - Metric Tube

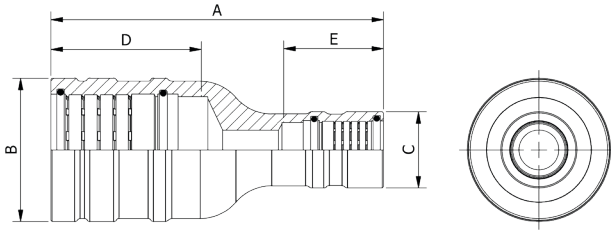

***MATERIAL CODE:**
K = STAINLESS STEEL
G = CARBON STEEL
B = COPPER NICKEL 70/30

ORDER EXAMPLE:
DM80101G0806

Other configurations available.
Contact factory for details.

Reducer, Metric - DM80101

End 1 Size OD (mm)	End 2 Size OD (mm)	Part Number	Dimensions - mm (Inch)					*Weight K & G kg (lbs)
			A	B	C	D Insertion Depth	E Insertion Depth	
8	6	DM80101*0806	50.80 (2.00)	12.19 (0.48)	9.40 (0.37)	19.30 (0.76)	16.51 (0.65)	0.02 (0.04)
10	8	DM80101*1008	57.15 (2.25)	15.09 (0.59)	12.19 (0.48)	24.13 (0.95)	19.30 (0.76)	0.09 (0.20)
12	10	DM80101*1210	63.50 (2.50)	18.59 (0.73)	14.99 (0.59)	26.92 (1.06)	24.13 (0.95)	0.05 (0.11)
15	10	DM80101*1510	73.15 (2.88)	23.70 (0.93)	14.99 (0.59)	32.00 (1.26)	24.13 (0.95)	0.09 (0.19)
15	12	DM80101*1512	73.15 (2.88)	23.70 (0.93)	18.54 (0.73)	32.00 (1.26)	26.92 (1.06)	0.10 (0.21)
16	10	DM80101*1610	73.15 (2.88)	23.70 (0.93)	14.99 (0.59)	32.00 (1.26)	24.13 (0.95)	0.07 (0.17)
16	12	DM80101*1612	76.20 (3.00)	23.70 (0.93)	18.54 (0.73)	32.00 (1.26)	26.92 (1.06)	0.10 (0.22)
18	12	DM80101*1812	76.20 (3.00)	25.15 (0.99)	18.54 (0.73)	35.05 (1.38)	26.92 (1.06)	0.09 (0.20)
18	15	DM80101*1815	76.20 (3.00)	25.15 (0.99)	23.62 (0.93)	35.05 (1.38)	32.00 (1.26)	0.14 (0.30)
20	12	DM80101*2012	82.55 (3.25)	28.70 (1.13)	18.54 (0.73)	37.08 (1.46)	26.92 (1.06)	0.14 (0.30)
20	16	DM80101*2016	88.90 (3.50)	28.70 (1.13)	23.62 (0.93)	37.08 (1.46)	32.00 (1.26)	0.16 (0.36)
22	15	DM80101*2215	85.85 (3.38)	30.48 (1.20)	23.62 (0.93)	38.10 (1.50)	32.00 (1.26)	0.16 (0.36)
22	18	DM80101*2218	85.85 (3.38)	30.48 (1.20)	25.15 (0.99)	38.10 (1.50)	35.05 (1.38)	0.15 (0.33)
25	16	DM80101*2516	95.25 (3.75)	35.31 (1.39)	23.62 (0.93)	41.91 (1.65)	32.00 (1.26)	0.23 (0.50)
25	20	DM80101*2520	99.06 (3.90)	35.31 (1.39)	28.70 (1.13)	41.91 (1.65)	37.08 (1.46)	0.25 (0.55)
28	18	DM80101*2818	95.55 (3.88)	37.59 (1.48)	25.15 (0.99)	44.45 (1.75)	35.05 (1.38)	0.25 (0.55)
28	22	DM80101*2822	107.95 (4.25)	37.59 (1.48)	30.48 (1.20)	44.45 (1.75)	38.10 (1.50)	0.29 (0.65)
30	20	DM80101*3020	107.95 (4.25)	41.91 (1.65)	28.70 (1.13)	46.99 (1.85)	37.08 (1.46)	0.31 (0.68)
30	25	DM80101*3025	114.30 (4.50)	41.91 (1.65)	35.31 (1.39)	46.99 (1.85)	41.91 (1.65)	0.38 (0.84)
35	22	DM80101*3522	114.30 (4.50)	46.23 (1.82)	30.48 (1.20)	50.80 (2.00)	38.10 (1.50)	0.45 (1.00)
35	28	DM80101*3528	120.65 (4.75)	46.23 (1.82)	37.59 (1.48)	50.80 (2.00)	44.45 (1.75)	0.48 (1.06)
38	25	DM80101*3825	120.65 (4.75)	52.07 (2.05)	35.31 (1.39)	54.61 (2.15)	41.91 (1.65)	0.64 (1.40)
38	30	DM80101*3830	130.02 (5.13)	52.07 (2.05)	41.91 (1.65)	54.61 (2.15)	46.99 (1.85)	0.75 (1.65)
42	35	DM80101*4235	133.35 (5.25)	57.50 (2.26)	46.23 (1.82)	60.45 (2.38)	50.80 (2.00)	0.83 (1.83)
42	38	DM80101*4238	143.00 (5.63)	57.50 (2.26)	52.07 (2.05)	60.45 (2.38)	54.61 (2.15)	1.00 (2.20)
50	38	DM80101*5038	152.40 (6.00)	65.53 (2.58)	52.07 (2.05)	63.50 (2.50)	54.61 (2.15)	1.22 (2.69)
50	42	DM80101*5042	158.75 (6.25)	65.53 (2.58)	57.40 (2.26)	63.50 (2.50)	60.45 (2.38)	1.31 (2.88)
60	38	DM80101*6038	165.10 (6.50)	77.22 (3.04)	52.07 (2.05)	88.90 (3.50)	54.61 (2.15)	1.81 (3.99)
60	50	DM80101*6050	174.75 (6.88)	77.22 (3.04)	65.53 (2.58)	88.90 (3.50)	63.50 (2.50)	1.90 (4.19)

3D step models available upon request

DM 80 Series - Metric Tube

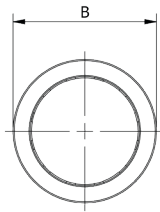
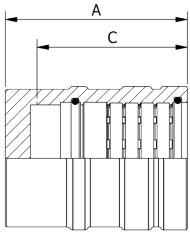

***MATERIAL CODE:**
 K = STAINLESS STEEL
 G = CARBON STEEL
 B = COPPER NICKEL 70/30

ORDER EXAMPLE:
 DM80085G06

End Cap, Metric - DM80085

Size OD (mm)	Part Number	Dimensions - mm (Inch)			*Weight K & G kg (lbs)
		A	B	C Insertion Depth	
6	DM80085*06	23.11 (0.91)	9.80 (0.39)	16.51 (0.65)	0.01 (0.02)
8	DM80085*08	29.21 (1.15)	12.19 (0.48)	19.30 (0.76)	0.01 (0.02)
10	DM80085*10	33.78 (1.33)	15.09 (0.59)	24.13 (0.95)	0.02 (0.05)
12	DM80085*12	37.59 (1.48)	18.59 (0.73)	26.92 (1.06)	0.04 (0.08)
15	DM80085*15	45.72 (1.80)	23.70 (0.93)	32.00 (1.26)	0.09 (0.19)
16	DM80085*16	45.72 (1.80)	23.70 (0.93)	32.00 (1.26)	0.08 (0.17)
18	DM80085*18	51.82 (2.04)	25.15 (0.99)	35.05 (1.38)	0.10 (0.21)
20	DM80085*20	55.63 (2.19)	28.70 (1.13)	37.08 (1.46)	0.14 (0.31)
22	DM80085*22	56.64 (2.23)	30.48 (1.20)	38.10 (1.50)	0.15 (0.33)
25	DM80085*25	60.71 (2.39)	35.31 (1.39)	41.91 (1.65)	0.23 (0.50)
28	DM80085*28	62.99 (2.48)	37.59 (1.48)	44.45 (1.75)	0.24 (0.52)
30	DM80085*30	65.53 (2.58)	41.91 (1.65)	46.99 (1.85)	0.34 (0.76)
35	DM80085*35	69.34 (2.73)	46.23 (1.82)	50.80 (2.00)	0.39 (0.85)
38	DM80085*38	73.15 (2.88)	52.07 (2.05)	54.61 (2.15)	0.62 (1.36)
42	DM20085*20	73.15 (2.88)	57.40 (2.26)	60.45 (2.38)	0.65 (1.44)
50	DM80085*50	82.04 (3.23)	65.53 (2.58)	63.50 (2.50)	0.92 (2.03)
**60K	DM20085K32	104.90 (4.13)	77.22 (3.04)	88.90 (3.50)	1.42 (3.13)
60G	DM80085G60	104.90 (4.13)	77.22 (3.04)	88.90 (3.50)	1.42 (3.13)

**2" DM 20 Series Stainless Steel fittings are also used for 60mm Stainless Steel applications.

DM 80 Series - Metric Tube

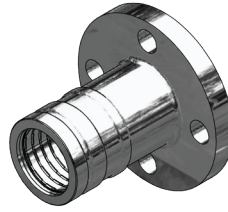
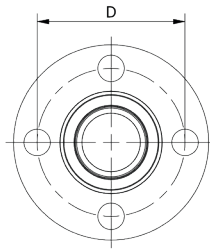
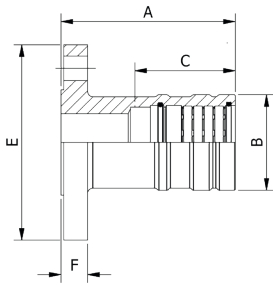

***MATERIAL CODE:**
 K = STAINLESS STEEL
 G = CARBON STEEL
 B = COPPER NICKEL 70/30

ORDER EXAMPLE:
 DM80028G2015

Flange – PN16, Metric - DM80028

Size OD (mm)	Flange Size	Part Number	Dimensions - mm (Inch)						Bolt Size	*Weight K & G kg (lbs)
			A	B	C Insertion Depth	D	E	F		
20	DN15	DM80028*2015	80.01 (3.15)	28.70 (1.13)	37.08 (1.46)	65.02 (2.56)	95.00 (3.74)	14.00 (0.55)	M12	0.79 (1.75)
25	DN20	DM80028*2520	85.09 (3.35)	35.31 (1.39)	41.91 (1.65)	74.93 (2.95)	104.90 (4.13)	16.00 (0.63)	M12	1.15 (2.54)
30	DN25	DM80028*3025	95.00 (3.74)	41.91 (1.65)	46.99 (1.85)	85.09 (3.35)	115.06 (4.53)	16.00 (0.63)	M12	1.36 (3.00)
38	DN32	DM80028*3832	100.08 (3.94)	52.07 (2.05)	54.61 (2.15)	100.08 (3.94)	139.95 (5.51)	16.00 (0.63)	M16	2.24 (4.93)
42	DN32	DM80028*4232	115.06 (4.53)	57.40 (2.26)	60.45 (2.38)	100.08 (3.94)	139.95 (5.51)	16.00 (0.63)	M16	2.54 (5.59)
50	DN40	DM80028*5040	115.06 (4.53)	65.53 (2.58)	63.50 (2.50)	109.98 (4.33)	150.11 (5.91)	16.00 (0.63)	M16	2.83 (6.25)
60	DN50	DM80028*6050	145.03 (5.71)	77.22 (3.04)	88.90 (3.50)	124.97 (4.92)	165.10 (6.50)	18.03 (0.71)	M16	4.17 (9.19)

DM80028G60 is made from ASTM-A105/A350 LF2 material.

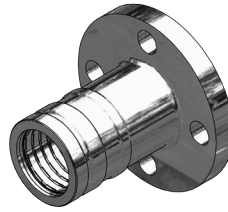
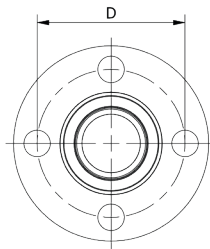
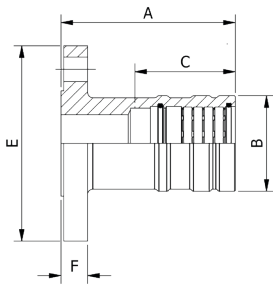

***MATERIAL CODE:**
 K = STAINLESS STEEL
 G = CARBON STEEL
 B = COPPER NICKEL 70/30

ORDER EXAMPLE:
 DM80029G2015

Flange – PN40, Metric - DM80029

Size OD (mm)	Flange Size	Part Number	Dimensions - mm (Inch)						Bolt Size	*Weight K & G kg (lbs)
			A	B	C Insertion Depth	D	E	F		
20	DN15	DM80029*2015	80.01 (3.15)	28.70 (1.13)	37.08 (1.46)	65.02 (2.56)	95.00 (3.74)	16.00 (0.63)	M12	0.89 (1.96)
25	DN20	DM80029*2520	85.09 (3.35)	35.31 (1.39)	41.91 (1.65)	74.93 (2.95)	104.90 (4.13)	18.03 (0.71)	M12	1.27 (2.79)
30	DN25	DM80029*3025	95.00 (3.74)	41.91 (1.65)	46.99 (1.85)	85.09 (3.35)	115.06 (4.53)	18.03 (0.71)	M12	1.48 (3.26)
38	DN32	DM80029*3832	100.08 (3.94)	52.07 (2.05)	54.61 (2.15)	100.08 (3.94)	139.95 (5.51)	18.03 (0.71)	M16	2.43 (5.36)
42	DN32	DM80029*4232	115.06 (4.53)	57.40 (2.26)	60.45 (2.38)	100.08 (3.94)	139.95 (5.51)	18.03 (0.71)	M16	2.73 (6.01)
50	DN40	DM80029*5040	118.36 (4.66)	65.53 (2.58)	63.50 (2.50)	109.98 (4.33)	150.11 (5.91)	18.03 (0.71)	M16	3.01 (6.63)
60	DN50	DM80029*6050	145.03 (5.71)	77.22 (3.04)	88.90 (3.50)	124.97 (4.92)	165.10 (6.50)	20.07 (0.79)	M16	4.42 (9.74)

DM80029G60 is made from ASTM-A105/A350 LF2 material.

3D step models available upon request

DM 80 Series - Metric Tube

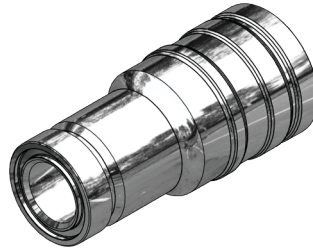
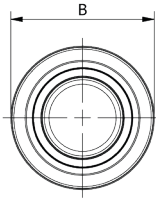
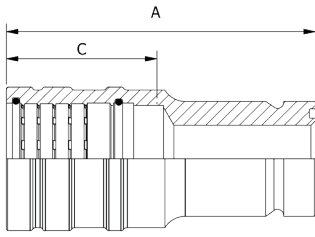

***MATERIAL CODE:**
 K = STAINLESS STEEL
 G = CARBON STEEL
 B = COPPER NICKEL 70/30

ORDER EXAMPLE:
 DM80090G1608

SAE Flange Body, Metric - DM80090

Size OD (mm)	Flange Size	Part Number	Dimensions - mm (Inch)			*Weight K & G kg (lbs)
			A	B	C Insertion Depth	
16	1/2"	DM80090*1608	82.80 (3.26)	23.70 (0.93)	32.00 (1.26)	0.20 (0.43)
18	1/2"	DM80090*1808	82.80 (3.26)	23.70 (0.93)	35.05 (1.38)	0.20 (0.44)
20	1/2"	DM80090*2008	84.84 (3.34)	28.70 (1.13)	37.08 (1.46)	0.19 (0.42)
22	1/2"	DM80090*2208	84.84 (3.34)	30.48 (1.20)	38.10 (1.50)	0.23 (0.51)
25	3/4"	DM80090*2512	92.71 (3.65)	35.31 (1.39)	41.91 (1.65)	0.41 (0.90)
28	3/4"	DM80090*2812	95.25 (3.75)	37.59 (1.48)	44.45 (1.75)	0.42 (0.93)
30	1"	DM80090*3016	97.79 (3.85)	41.91 (1.65)	46.99 (1.85)	0.52 (1.14)
35	1"	DM80090*3516	107.95 (4.25)	46.23 (1.82)	50.80 (2.00)	0.59 (1.29)
38	1-1/4"	DM80090*3820	118.11 (4.65)	52.07 (2.05)	54.61 (2.15)	0.82 (1.80)
42	1-1/4"	DM20090*20	123.95 (4.88)	57.40 (2.26)	60.45 (2.38)	0.97 (2.13)
50	1-1/2"	DM80090*5024	136.65 (5.38)	65.53 (2.58)	63.50 (2.50)	1.41 (3.10)
**60K	2"	DM20090K32	165.10 (6.50)	77.22 (3.04)	88.90 (3.50)	2.01 (4.43)
60G	2"	DM80090G6032	165.10 (6.50)	77.22 (3.04)	88.90 (3.50)	2.01 (4.43)

**2" DM 20 Series Stainless Steel fittings are also used for 60mm Stainless Steel applications.

DM 80 Series - Metric Tube

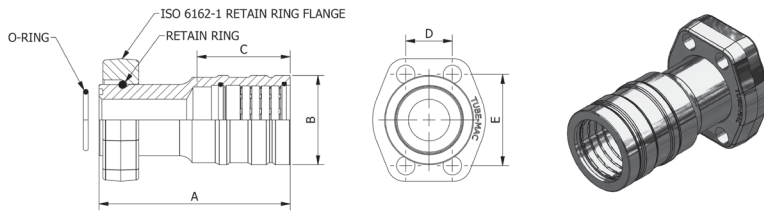

***MATERIAL CODE:**
K = STAINLESS STEEL
G = CARBON STEEL
B = COPPER NICKEL 70/30

ORDER EXAMPLE:
DM80091G1608

ISO 6162-1 Flange, Metric - DM80091

Size OD (mm)	Flange Size	Part Number	Dimensions - mm (Inch)					Bolt Size	*Weight K & G kg (lbs)
			A	B	C Insertion Depth	D	E		
16	1/2"	DM80091*1608	82.80 (3.26)	23.70 (0.93)	32.00 (1.26)	17.53 (0.69)	38.10 (1.50)	M8	0.40 (0.89)
18	1/2"	DM80091*1808	82.80 (3.26)	25.15 (0.99)	35.05 (1.38)	17.53 (0.69)	38.10 (1.50)	M8	0.41 (0.90)
20	1/2"	DM80091*2008	84.84 (3.34)	28.70 (1.13)	37.08 (1.46)	17.53 (0.69)	38.10 (1.50)	M8	0.40 (0.88)
22	1/2"	DM80091*2208	84.84 (3.34)	30.48 (1.20)	38.10 (1.50)	17.53 (0.69)	38.10 (1.50)	M8	0.44 (0.97)
25	3/4"	DM80091*2512	92.71 (3.65)	35.31 (1.39)	41.91 (1.65)	22.35 (0.88)	47.75 (1.88)	M10	0.64 (1.40)
28	3/4"	DM80091*2812	95.25 (3.75)	37.59 (1.48)	44.45 (1.75)	22.35 (0.88)	47.75 (1.88)	M10	0.65 (1.43)
30	1"	DM80091*3016	97.79 (3.85)	41.91 (1.65)	46.99 (1.85)	26.16 (1.03)	52.32 (2.06)	M10	0.80 (1.77)
35	1"	DM80091*3516	107.95 (4.25)	46.23 (1.82)	50.80 (2.00)	26.16 (1.03)	52.32 (2.06)	M10	0.87 (1.92)
38	1-1/4"	DM80091*3820	118.11 (4.65)	52.07 (2.05)	54.61 (2.15)	30.23 (1.19)	58.67 (2.31)	M10	1.22 (2.70)
42	1-1/4"	DM20091*20	123.95 (4.88)	57.40 (2.26)	60.45 (2.38)	30.23 (1.19)	58.67 (2.31)	M10	1.37 (3.03)
50	1-1/2"	DM80091*5024	136.65 (5.38)	65.53 (2.58)	63.50 (2.50)	35.81 (1.41)	69.85 (2.75)	M12	2.02 (4.45)
**60K	2"	DM20091K32	165.10 (6.50)	77.22 (3.04)	88.90 (3.50)	42.93 (1.69)	77.22 (3.06)	M12	2.93 (6.45)
60G	2"	DM80091G6032	165.10 (6.50)	77.22 (3.04)	88.90 (3.50)	42.93 (1.69)	77.22 (3.06)	M12	2.93 (6.45)

**2" DM 20 Series Stainless Steel fittings are also used for 60mm Stainless Steel applications.

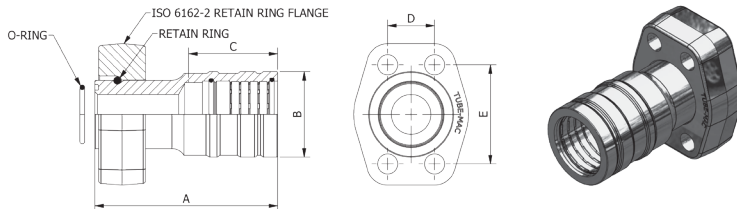

***MATERIAL CODE:**
K = STAINLESS STEEL
G = CARBON STEEL
B = COPPER NICKEL 70/30

ORDER EXAMPLE:
DM80092G1608

ISO 6162-2 Flange, Metric - DM80092

Size OD (mm)	Flange Size	Part Number	Dimensions - mm (Inch)					Bolt Size	*Weight K & G kg (lbs)
			A	B	C Insertion Depth	D	E		
16	1/2"	DM80092*1608	82.80 (3.26)	23.70 (0.93)	32.00 (1.26)	18.29 (0.72)	40.39 (1.59)	M8	0.40 (0.89)
18	1/2"	DM80092*1808	82.80 (3.26)	25.15 (0.99)	35.05 (1.38)	18.29 (0.72)	40.39 (1.59)	M8	0.41 (0.90)
20	1/2"	DM80092*2008	84.84 (3.34)	28.70 (1.13)	37.08 (1.46)	18.29 (0.72)	40.39 (1.59)	M8	0.40 (0.88)
22	1/2"	DM80092*2208	84.84 (3.34)	30.48 (1.20)	38.10 (1.50)	18.29 (0.72)	40.39 (1.59)	M8	0.44 (0.97)
25	3/4"	DM80092*2512	92.71 (3.65)	35.31 (1.39)	41.91 (1.65)	23.88 (0.94)	50.80 (2.00)	M10	0.78 (1.71)
28	3/4"	DM80092*2812	95.25 (3.75)	37.59 (1.48)	44.45 (1.75)	23.88 (0.94)	50.80 (2.00)	M10	0.79 (1.74)
30	1"	DM80092*3016	97.79 (3.85)	41.91 (1.65)	46.99 (1.85)	27.69 (1.09)	57.15 (2.25)	M12	1.09 (2.40)
35	1"	DM80092*3516	107.95 (4.25)	46.23 (1.82)	50.80 (2.00)	27.69 (1.09)	57.15 (2.25)	M12	1.16 (2.55)
38	1-1/4"	DM80092*3820	118.11 (4.65)	52.07 (2.05)	54.61 (2.15)	31.75 (1.25)	66.80 (2.63)	M14	1.70 (3.75)
42	1-1/4"	DM20092*20	123.95 (4.88)	57.40 (2.26)	60.45 (2.38)	31.75 (1.25)	66.80 (2.63)	M14	1.85 (4.08)
50	1-1/2"	DM80092*5024	136.65 (5.38)	65.53 (2.58)	63.50 (2.50)	36.58 (1.44)	79.50 (3.13)	M16	2.71 (5.98)
**60K	2"	DM20092K32	165.10 (6.50)	77.22 (3.04)	88.90 (3.50)	44.45 (1.75)	96.77 (3.81)	M20	4.46 (9.83)
60G	2"	DM80092G6032	165.10 (6.50)	77.22 (3.04)	88.90 (3.50)	44.45 (1.75)	96.77 (3.81)	M20	4.46 (9.83)

**2" DM 20 Series Stainless Steel fittings are also used for 60mm Stainless Steel applications.

3D step models available upon request

DM 80 Series - Metric Tube

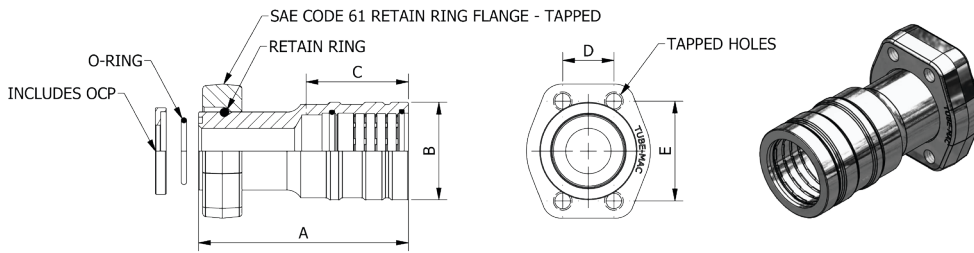

*MATERIAL CODE:
 K = STAINLESS STEEL
 G = CARBON STEEL
 B = COPPER NICKEL 70/30

ORDER EXAMPLE:
 DM80095G1608

ISO 6162-1 Tapped Flange, Metric - DM80095

Size OD (mm)	Flange Size	Part Number	Dimensions - mm (Inch)					Metric Tap	*Weight K & G kg (lbs)
			A	B	C Insertion Depth	D	E		
16	1/2"	DM80095*1608	82.80 (3.26)	23.70 (0.93)	32.00 (1.26)	17.53 (0.69)	38.10 (1.50)	M8	0.40 (0.89)
18	1/2"	DM80095*1808	82.80 (3.26)	25.15 (0.99)	35.05 (1.38)	17.53 (0.69)	38.10 (1.50)	M8	0.41 (0.90)
20	1/2"	DM80095*2008	84.84 (3.34)	28.70 (1.13)	37.08 (1.46)	17.53 (0.69)	38.10 (1.50)	M8	0.40 (0.88)
22	1/2"	DM80095*2208	84.84 (3.34)	30.48 (1.20)	38.10 (1.50)	17.53 (0.69)	38.10 (1.50)	M8	0.44 (0.97)
25	3/4"	DM80095*2512	92.71 (3.65)	35.31 (1.39)	41.91 (1.65)	22.35 (0.88)	47.75 (1.88)	M10	0.64 (1.40)
28	3/4"	DM80095*2812	95.25 (3.75)	37.59 (1.48)	44.45 (1.75)	22.35 (0.88)	47.75 (1.88)	M10	0.65 (1.43)
30	1"	DM80095*3016	97.79 (3.85)	41.91 (1.65)	46.99 (1.85)	26.16 (1.03)	52.32 (2.06)	M10	0.80 (1.77)
35	1"	DM80095*3516	107.95 (4.25)	46.23 (1.82)	50.80 (2.00)	26.16 (1.03)	52.32 (2.06)	M10	0.87 (1.92)
38	1-1/4"	DM80095*3820	118.11 (4.65)	52.07 (2.05)	54.61 (2.15)	30.23 (1.19)	58.67 (2.31)	M10	1.22 (2.70)
42	1-1/4"	DM80095*4220	123.95 (4.88)	57.40 (2.26)	60.45 (2.38)	30.23 (1.19)	58.67 (2.31)	M10	1.37 (3.03)
50	1-1/2"	DM80095*5024	136.65 (5.38)	65.53 (2.58)	63.50 (2.50)	35.81 (1.41)	69.85 (2.75)	M12	2.02 (4.45)
**60K	2"	DM80095K6032	165.10 (6.50)	77.22 (3.04)	88.90 (3.50)	42.93 (1.69)	77.22 (3.06)	M12	2.93 (6.45)
60G	2"	DM80095G6032	165.10 (6.50)	77.22 (3.04)	88.90 (3.50)	42.93 (1.69)	77.22 (3.06)	M12	2.93 (6.45)

**2" DM 20 Series Stainless Steel fittings are also used for 60mm Stainless Steel applications.

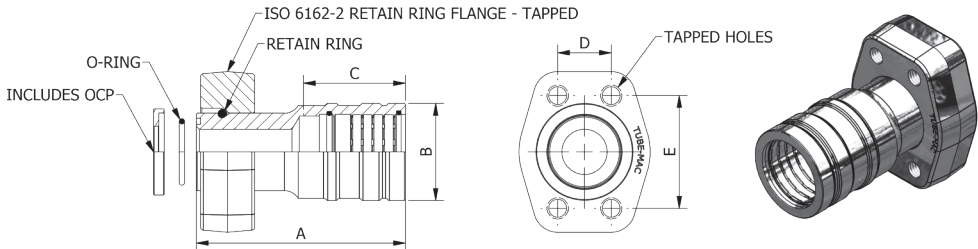

*MATERIAL CODE:
 K = STAINLESS STEEL
 G = CARBON STEEL
 B = COPPER NICKEL 70/30

ORDER EXAMPLE:
 DM80096G1608

ISO 6162-2 Tapped Flange, Metric - DM80096

Size OD (mm)	Flange Size	Part Number	Dimensions - mm (Inch)					Metric Tap	*Weight K & G kg (lbs)
			A	B	C Insertion Depth	D	E		
16	1/2"	DM80096*1608	82.80 (3.26)	23.70 (0.93)	32.00 (1.26)	18.29 (0.72)	40.39 (1.59)	M8	0.40 (0.89)
18	1/2"	DM80096*1808	82.80 (3.26)	25.15 (0.99)	35.05 (1.38)	18.29 (0.72)	40.39 (1.59)	M8	0.41 (0.90)
20	1/2"	DM80096*2008	84.84 (3.34)	28.70 (1.13)	37.08 (1.46)	18.29 (0.72)	40.39 (1.59)	M8	0.40 (0.88)
22	1/2"	DM80096*2208	84.84 (3.34)	30.48 (1.20)	38.10 (1.50)	18.29 (0.72)	40.39 (1.59)	M8	0.44 (0.97)
25	3/4"	DM80096*2512	92.71 (3.65)	35.31 (1.39)	41.91 (1.65)	23.88 (0.94)	50.80 (2.00)	M10	0.78 (1.71)
28	3/4"	DM80096*2812	95.25 (3.75)	37.59 (1.48)	44.45 (1.75)	23.88 (0.94)	50.80 (2.00)	M10	0.79 (1.74)
30	1"	DM80096*3016	97.79 (3.85)	41.91 (1.65)	46.99 (1.85)	27.69 (1.09)	57.15 (2.25)	M12	1.09 (2.40)
35	1"	DM80096*3516	107.95 (4.25)	46.23 (1.82)	50.80 (2.00)	27.69 (1.09)	57.15 (2.25)	M12	1.16 (2.55)
38	1-1/4"	DM80096*3820	118.11 (4.65)	52.07 (2.05)	54.61 (2.15)	31.75 (1.25)	66.80 (2.63)	M14	1.70 (3.75)
42	1-1/4"	DM80096*4220	123.95 (4.88)	57.40 (2.26)	60.45 (2.38)	31.75 (1.25)	66.80 (2.63)	M14	1.85 (4.08)
50	1-1/2"	DM80096*5024	136.65 (5.38)	65.53 (2.58)	63.50 (2.50)	36.58 (1.44)	79.50 (3.13)	M16	2.71 (5.98)
**60K	2"	DM80096K6032	165.10 (6.50)	77.22 (3.04)	88.90 (3.50)	44.45 (1.75)	96.77 (3.81)	M20	4.46 (9.83)
60G	2"	DM80096G6032	165.10 (6.50)	77.22 (3.04)	88.90 (3.50)	44.45 (1.75)	96.77 (3.81)	M20	4.46 (9.83)

**2" DM 20 Series Stainless Steel fittings are also used for 60mm Stainless Steel applications.

3D step models available upon request

DM 80 Series - Metric Tube

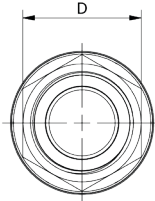
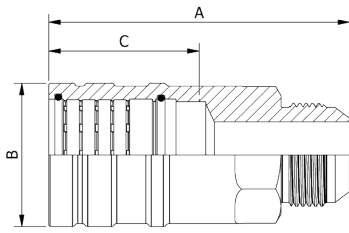

***MATERIAL CODE:**
K = STAINLESS STEEL
G = CARBON STEEL
B = COPPER NICKEL 70/30

ORDER EXAMPLE:
DM80055G0604

JIC 37° Male, Metric - DM80055

Size OD (mm)	JIC Size	Part Number	Dimensions - mm (Inch)				*Weight K & G kg (lbs)
			A	B	C Insertion Depth	D	
6	04	DM80055*0604	42.67 (1.68)	9.80 (0.39)	16.51 (0.65)	12.70 (0.50)	0.02 (0.04)
8	04	DM80055*0804	46.48 (1.83)	12.19 (0.48)	19.30 (0.76)	12.70 (0.50)	0.03 (0.05)
10	06	DM80055*1006	49.53 (1.95)	15.09 (0.59)	24.13 (0.95)	16.00 (0.63)	0.04 (0.08)
12	08	DM80055*1208	60.45 (2.38)	18.59 (0.73)	26.92 (1.06)	22.10 (0.87)	0.08 (0.18)
16	10	DM80055*1610	66.80 (2.63)	23.70 (0.93)	32.00 (1.26)	26.92 (1.06)	0.12 (0.27)
20	12	DM80055*2012	84.58 (3.33)	28.70 (1.13)	37.08 (1.46)	28.70 (1.13)	0.15 (0.33)
25	16	DM80055*2516	89.92 (3.54)	35.31 (1.39)	41.91 (1.65)	35.05 (1.38)	0.31 (0.69)
30	20	DM80055*3020	101.60 (4.00)	41.91 (1.65)	46.99 (1.85)	47.75 (1.88)	0.54 (1.18)
38	24	DM80055*3824	117.60 (4.63)	52.07 (2.05)	54.61 (2.15)	50.80 (2.00)	0.82 (1.81)
42	24	DM80055*4224	117.60 (4.63)	57.40 (2.26)	60.45 (2.38)	57.15 (2.25)	1.04 (2.29)
50	24	DM80055*5024	127.00 (5.00)	65.53 (2.58)	63.50 (2.50)	66.80 (2.63)	1.32 (2.91)

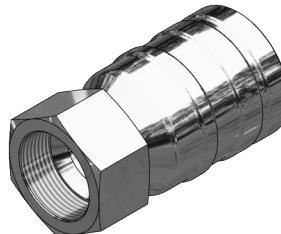
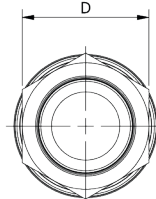
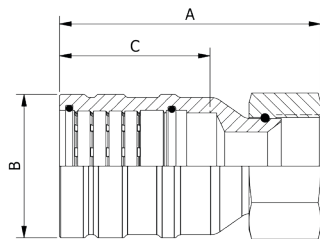

***MATERIAL CODE:**
K = STAINLESS STEEL
G = CARBON STEEL
B = COPPER NICKEL 70/30

ORDER EXAMPLE:
DM80054G0604

JIC 37° Female Swivel, Metric - DM80054

Size OD (mm)	JIC Size	Part Number	Dimensions - mm (Inch)				*Weight K & G kg (lbs)
			A	B	C Insertion Depth	D	
6	04	DM80054*0604	42.42 (1.67)	9.80 (0.39)	16.51 (0.65)	14.22 (0.56)	0.02 (0.05)
8	04	DM80054*0804	42.42 (1.67)	12.19 (0.48)	19.30 (0.76)	14.22 (0.56)	0.03 (0.06)
10	06	DM80054*1006	48.01 (1.91)	15.09 (0.59)	24.13 (0.95)	17.53 (0.69)	0.04 (0.09)
12	08	DM80054*1208	57.65 (2.27)	18.59 (0.73)	26.92 (1.06)	22.35 (0.88)	0.07 (0.16)
16	10	DM80054*1610	62.74 (2.47)	23.70 (0.93)	32.00 (1.26)	25.40 (1.00)	0.11 (0.25)
20	12	DM80054*2012	78.74 (3.10)	28.70 (1.13)	37.08 (1.46)	31.75 (1.25)	0.22 (0.48)
25	16	DM80054*2516	81.28 (3.20)	35.31 (1.39)	41.91 (1.65)	38.10 (1.50)	0.29 (0.65)
30	20	DM80054*3020	92.20 (3.63)	41.91 (1.65)	46.99 (1.85)	50.80 (2.00)	0.56 (1.24)
38	24	DM80054*3824	114.30 (4.50)	52.07 (2.05)	54.61 (2.15)	57.15 (2.25)	0.95 (2.10)
42	24	DM80054*4224	123.95 (4.88)	57.40 (2.26)	60.45 (2.38)	57.15 (2.25)	1.13 (2.49)
50	24	DM80054*5024	128.02 (5.04)	65.53 (2.58)	63.50 (2.50)	83.82 (3.30)	1.59 (3.51)

3D step models available upon request

DM 80 Series - Metric Tube

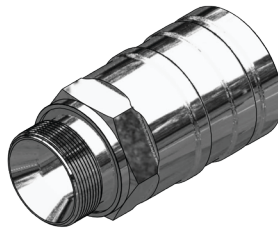
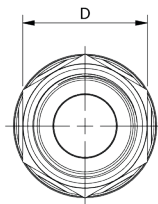
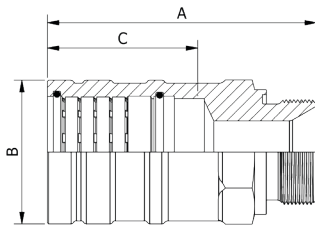

***MATERIAL CODE:**
K = STAINLESS STEEL
G = CARBON STEEL
B = COPPER NICKEL 70/30

ORDER EXAMPLE:
DM80153G0604

BSPP Male, Metric - DM80153

Size OD (mm)	BSPP Size	Part Number	Dimensions - mm (Inch)				*Weight K & G kg (lbs)
			A	B	C Insertion Depth	D	
6	1/4"	DM80153*0604	43.43 (1.71)	9.80 (0.39)	16.51 (0.65)	19.05 (0.75)	0.03 (0.07)
8	1/4"	DM80153*0804	45.97 (1.81)	12.19 (0.48)	19.30 (0.76)	19.05 (0.75)	0.04 (0.08)
10	1/4"	DM80153*1004	51.05 (2.01)	15.09 (0.59)	24.13 (0.95)	19.05 (0.75)	0.05 (0.10)
12	1/4"	DM80153*1204	53.84 (2.12)	18.59 (0.73)	26.92 (1.06)	19.05 (0.75)	0.05 (0.12)
15	3/8"	DM80153*1506	58.93 (2.32)	23.70 (0.93)	32.00 (1.26)	22.10 (0.87)	0.10 (0.22)
16	3/8"	DM80153*1606	58.93 (2.32)	23.70 (0.93)	32.00 (1.26)	22.10 (0.87)	0.09 (0.20)
18	3/8"	DM80153*1806	61.98 (2.44)	25.15 (0.99)	35.05 (1.38)	22.10 (0.87)	0.12 (0.27)
20	1/2"	DM80153*2008	66.29 (2.61)	28.70 (1.13)	37.08 (1.46)	29.97 (1.18)	0.15 (0.34)
22	1/2"	DM80153*2208	72.14 (2.84)	30.48 (1.20)	38.10 (1.50)	32.00 (1.26)	0.18 (0.40)
25	3/4"	DM80153*2512	83.06 (3.27)	35.31 (1.39)	41.91 (1.65)	36.07 (1.42)	0.28 (0.62)
28	3/4"	DM80153*2812	85.60 (3.37)	37.59 (1.48)	44.45 (1.75)	36.07 (1.42)	0.33 (0.72)
30	1"	DM80153*3016	85.09 (3.35)	41.91 (1.65)	46.99 (1.85)	45.97 (1.80)	0.43 (0.94)
35	1"	DM80153*3516	88.90 (3.50)	46.23 (1.82)	50.80 (2.00)	50.04 (1.97)	0.50 (1.11)
38	1-1/4"	DM80153*3820	109.73 (4.32)	52.07 (2.05)	54.61 (2.15)	56.13 (2.21)	0.95 (2.10)
42	1-1/4"	DM20153*20	107.95 (4.25)	57.40 (2.26)	60.45 (2.38)	50.04 (1.97)	0.88 (1.95)
50	1-1/2"	DM80153*5024	115.57 (4.55)	65.53 (2.58)	63.50 (2.50)	55.12 (2.17)	1.15 (2.53)
**60K	2"	DM20153K32	136.65 (5.38)	77.22 (3.04)	88.90 (3.50)	74.93 (2.95)	1.58 (3.49)
60G	2"	DM80153G6032	136.65 (5.38)	77.22 (3.04)	88.90 (3.50)	74.93 (2.95)	1.58 (3.49)

**2" DM 20 Series Stainless Steel fittings are also used for 60mm Stainless Steel applications.

DM 80 Series - Metric Tube

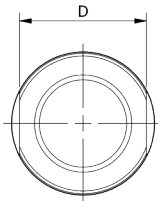
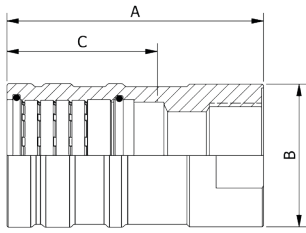

***MATERIAL CODE:**
K = STAINLESS STEEL
G = CARBON STEEL
B = COPPER NICKEL 70/30

ORDER EXAMPLE:
DM80086G0604

BSPP Female, Metric - DM80086

Size OD (mm)	BSPP Size	Part Number	Dimensions - mm (Inch)				*Weight K & G kg (lbs)
			A	B	C Insertion Depth	D	
6	1/4"	DM80086*0604	42.16 (1.66)	23.88 (0.94)	16.51 (0.65)	20.07 (0.79)	0.05 (0.10)
8	1/4"	DM80086*0804	44.70 (1.76)	23.88 (0.94)	19.30 (0.76)	20.07 (0.79)	0.05 (0.11)
10	1/4"	DM80086*1004	49.78 (1.96)	23.88 (0.94)	24.13 (0.95)	20.07 (0.79)	0.06 (0.14)
12	1/4"	DM80086*1204	51.82 (2.04)	23.88 (0.94)	26.92 (1.06)	20.07 (0.79)	0.07 (0.16)
15	3/8"	DM80086*1506	57.40 (2.26)	26.92 (1.06)	32.00 (1.26)	22.10 (0.87)	0.06 (0.13)
16	3/8"	DM80086*1606	57.40 (2.26)	26.92 (1.06)	32.00 (1.26)	22.10 (0.87)	0.06 (0.13)
18	3/8"	DM80086*1806	57.40 (2.26)	26.92 (1.06)	35.05 (1.38)	22.10 (0.87)	0.11 (0.24)
20	1/2"	DM80086*2008	75.18 (2.96)	34.29 (1.35)	37.08 (1.46)	30.23 (1.19)	0.26 (0.57)
22	1/2"	DM80086*2208	73.15 (2.88)	34.29 (1.35)	38.10 (1.50)	30.23 (1.19)	0.23 (0.51)
25	3/4"	DM80086*2512	89.92 (3.54)	38.10 (1.50)	41.91 (1.65)	37.75 (1.25)	0.38 (0.83)
28	3/4"	DM80086*2812	89.92 (3.54)	38.10 (1.50)	41.91 (1.65)	37.75 (1.25)	0.38 (0.84)
30	1"	DM80086*3016	98.55 (3.88)	47.75 (1.88)	46.99 (1.85)	41.40 (1.63)	0.57 (1.25)
35	1"	DM80086*3516	98.55 (3.88)	47.75 (1.88)	50.80 (2.00)	41.40 (1.63)	0.60 (1.32)
38	1-1/4"	DM80086*3820	113.28 (4.46)	57.15 (2.25)	54.61 (2.15)	50.80 (2.00)	1.03 (2.27)
42	1-1/4"	DM20086*20	102.87 (4.05)	57.15 (2.25)	60.45 (2.38)	50.80 (2.00)	0.87 (1.91)
50	1-1/2"	DM80086*5024	114.30 (4.50)	69.85 (2.75)	63.50 (2.50)	63.50 (2.50)	1.36 (3.00)
**60K	2"	DM20086K32	146.05 (5.75)	88.90 (3.50)	88.90 (3.50)	76.20 (3.00)	2.33 (5.14)
60G	2"	DM80086G6032	146.05 (5.75)	88.90 (3.50)	88.90 (3.50)	76.20 (3.00)	2.33 (5.14)

**2" DM 20 Series Stainless Steel fittings are also used for 60mm Stainless Steel applications.

3D step models available upon request

DM 80 Series - Metric Tube

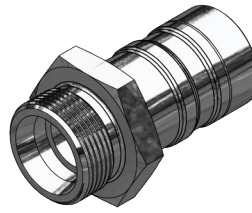
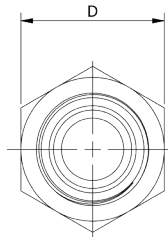
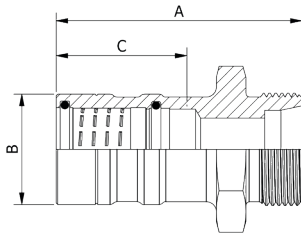

***MATERIAL CODE:**
K = STAINLESS STEEL
G = CARBON STEEL
B = COPPER NICKEL 70/30

ORDER EXAMPLE:
DM80066G06S

DIN 24° Male, Metric - DM80066

Size OD (mm)	DIN 2353/ISO 8434-1 L & S Series Thread	Part Number	Dimensions - mm (Inch)				*Weight K & G kg (lbs)
			A	B	C Insertion Depth	D	
6	6L - M12 x 1.5	DM80066*06L	38.86 (1.53)	9.80 (0.39)	16.51 (0.65)	13.97 (0.55)	0.02 (0.05)
6	6S - M14 x 1.5	DM80066*06S	38.86 (1.53)	9.80 (0.39)	16.51 (0.65)	17.02 (0.67)	0.03 (0.06)
8	8L - M14 x 1.5	DM80066*08L	50.55 (1.99)	12.19 (0.48)	19.30 (0.76)	17.02 (0.67)	0.04 (0.09)
8	8S - M16 x 1.5	DM80066*08S	53.09 (2.09)	12.19 (0.48)	19.30 (0.76)	17.02 (0.67)	0.05 (0.10)
10	10L - M16 x 1.5	DM80066*10L	54.61 (2.15)	15.09 (0.59)	24.13 (0.95)	19.05 (0.75)	0.05 (0.12)
10	10S - M18 x 1.5	DM80066*10S	57.66 (2.27)	15.09 (0.59)	24.13 (0.95)	22.10 (0.87)	0.07 (0.16)
12	12L - M18 x 1.5	DM80066*12L	52.07 (2.05)	18.59 (0.73)	26.92 (1.06)	24.13 (0.95)	0.07 (0.17)
12	12S - M20 x 1.5	DM80066*12S	56.64 (2.23)	18.59 (0.73)	26.92 (1.06)	22.10 (0.87)	0.08 (0.18)
15	15L - M22 x 1.5	DM80066*15L	57.40 (2.26)	23.70 (0.93)	32.00 (1.26)	26.92 (1.06)	0.10 (0.27)
16	16S - M24 x 1.5	DM80066*16S	62.99 (2.48)	23.70 (0.93)	32.00 (1.26)	26.92 (1.06)	0.14 (0.31)
18	18L - M26 x 1.5	DM80066*18L	60.45 (2.38)	25.15 (0.99)	35.05 (1.38)	32.00 (1.26)	0.14 (0.31)
20	20S - M30 x 2.0	DM80066*20S	67.82 (2.67)	28.70 (1.13)	37.08 (1.46)	36.07 (1.42)	0.22 (0.48)
22	22L - M30 x 2.0	DM80066*22L	68.58 (2.70)	30.48 (1.20)	38.10 (1.50)	36.07 (1.42)	0.22 (0.48)
25	25S - M36 x 2.0	DM80066*25S	78.74 (3.10)	35.31 (1.39)	41.91 (1.65)	45.97 (1.81)	0.34 (0.76)
28	28L - M36 x 2.0	DM80066*28L	82.04 (3.23)	37.59 (1.48)	44.45 (1.75)	40.89 (1.61)	0.30 (0.67)
30	30S - M42 x 2.0	DM80066*30S	85.60 (3.37)	41.91 (1.65)	46.99 (1.85)	50.04 (1.97)	0.48 (1.05)
35	35L - M45 x 2.0	DM80066*35L	85.09 (3.35)	46.23 (1.82)	50.80 (2.00)	50.04 (1.97)	0.49 (1.09)
38	38S - M52 x 2.0	DM80066*38S	100.84 (3.97)	52.07 (2.05)	54.61 (2.15)	59.94 (2.36)	0.84 (1.85)
42	42L - M52 x 2.0	DM80066*42L	95.50 (3.76)	57.40 (2.26)	60.45 (2.38)	59.94 (2.36)	0.81 (1.79)

DM 80 Series - Metric Tube

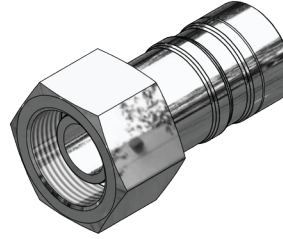
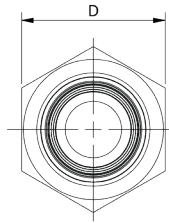
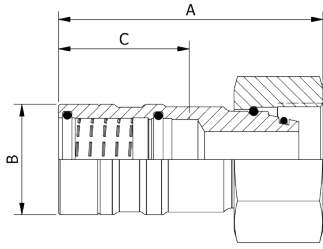

*MATERIAL CODE:
 K = STAINLESS STEEL
 G = CARBON STEEL
 B = COPPER NICKEL 70/30

ORDER EXAMPLE:
 DM80068G06S

DIN 24° Female Swivel, Metric - DM80068

Size OD (mm)	DIN 2353/ISO 8434-1 L & S Series Thread	Part Number	Dimensions - mm (Inch)				*Weight K & G kg (lbs)
			A	B	C Insertion Depth	D	
6	6L - M12 x 1.5	DM80068*06L	39.00 (1.54)	9.80 (0.39)	16.51 (0.65)	13.97 (0.55)	0.03 (0.06)
6	6S - M14 x 1.5	DM80068*06S	42.42 (1.67)	9.80 (0.39)	16.51 (0.65)	17.02 (0.67)	0.03 (0.07)
8	8L - M12 x 1.5	DM80068*08L	42.93 (1.69)	12.19 (0.48)	19.30 (0.76)	17.02 (0.67)	0.04 (0.08)
8	8S - M16 x 1.5	DM80068*08S	48.26 (1.90)	12.19 (0.48)	19.30 (0.76)	18.80 (0.74)	0.05 (0.10)
10	10L - M16 x 1.5	DM80068*10L	51.31 (2.02)	15.09 (0.59)	24.13 (0.95)	18.80 (0.74)	0.05 (0.11)
10	10S - M18 x 1.5	DM80068*10S	51.56 (2.03)	15.09 (0.59)	24.13 (0.95)	21.84 (0.86)	0.06 (0.14)
12	12L - M18 x 1.5	DM80068*12L	53.85 (2.12)	18.59 (0.73)	26.92 (1.06)	21.84 (0.86)	0.07 (0.16)
12	12S - M20 x 1.5	DM80068*12S	52.58 (2.07)	18.59 (0.73)	26.92 (1.06)	23.62 (0.93)	0.09 (0.19)
15	15L - M22 x 1.5	DM80068*15L	61.98 (2.44)	23.70 (0.93)	32.00 (1.26)	26.92 (1.06)	0.14 (0.30)
16	16S - M24 x 1.5	DM80068*16S	60.45 (2.38)	23.70 (0.93)	32.00 (1.26)	29.72 (1.17)	0.15 (0.32)
18	18L - M26 x 1.5	DM80068*18L	65.53 (2.58)	25.15 (0.99)	35.05 (1.38)	32.00 (1.26)	0.17 (0.37)
20	20S - M30 x 2.0	DM80068*20S	68.33 (2.69)	28.70 (1.13)	37.08 (1.46)	35.81 (1.41)	0.21 (0.47)
22	22L - M30 x 2.0	DM80068*22L	73.15 (2.88)	30.48 (1.20)	38.10 (1.50)	35.81 (1.41)	0.25 (0.56)
25	25S - M36 x 2.0	DM80068*25S	84.84 (3.34)	35.31 (1.39)	41.91 (1.65)	45.72 (1.80)	0.45 (1.00)
28	28L - M36 x 2.0	DM80068*28L	76.96 (3.03)	37.59 (1.48)	44.45 (1.75)	40.89 (1.61)	0.32 (0.70)
30	30S - M42 x 2.0	DM80068*30S	89.92 (3.54)	41.91 (1.65)	46.99 (1.85)	49.78 (1.96)	0.53 (1.17)
35	35L - M45 x 2.0	DM80068*35L	92.96 (3.66)	46.23 (1.82)	50.80 (2.00)	50.04 (1.97)	0.55 (1.22)
38	38S - M52 x 2.0	DM80068*38S	105.41 (4.15)	52.07 (2.05)	54.61 (2.15)	59.69 (2.35)	0.98 (2.16)
42	42L - M52 x 2.0	DM80068*42L	107.44 (4.23)	57.40 (2.26)	60.45 (2.38)	60.20 (2.37)	1.03 (2.27)

DM 80 Series - Metric Tube

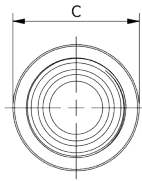
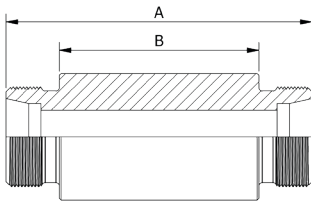

*MATERIAL CODE:
 K = STAINLESS STEEL
 G = CARBON STEEL
 B = COPPER NICKEL 70/30

ORDER EXAMPLE:
 DM80089G06S

Weldable Bulkhead, Metric - DM80089

Size OD (mm)	DIN 2353/ISO 8434-1 L & S Series Thread	Part Number	Dimensions - mm (Inch)			*Weight K & G kg (lbs)
			A	B	C	
6	6L - M12 x 1.5	DM80089*06L	73.91 (2.91)	49.78 (1.96)	20.00 (0.79)	0.14 (0.30)
6	6S - M14 x 1.5	DM80089*06S	73.91 (2.91)	49.78 (1.96)	20.00 (0.79)	0.14 (0.30)
8	8L - M14 x 1.5	DM80089*08L	73.91 (2.91)	48.01 (1.89)	22.00 (0.87)	0.17 (0.37)
8	8S - M16 x 1.5	DM80089*08S	73.91 (2.91)	53.09 (2.09)	22.00 (0.87)	0.16 (0.36)
10	10L - M16 x 1.5	DM80089*10L	73.91 (2.91)	50.04 (1.97)	25.00 (0.98)	0.21 (0.46)
10	10S - M18 x 1.5	DM80089*10S	73.91 (2.91)	52.07 (2.05)	25.00 (0.98)	0.20 (0.45)
12	12L - M18 x 1.5	DM80089*12L	73.91 (2.91)	50.04 (1.97)	25.00 (0.98)	0.18 (0.40)
12	12S - M20 x 1.5	DM80089*12S	73.91 (2.91)	51.82 (2.04)	28.00 (1.10)	0.25 (0.56)
15	15L - M22 x 1.5	DM80089*15L	84.07 (3.31)	59.94 (2.36)	28.00 (1.10)	0.27 (0.59)
16	16S - M24 x 1.5	DM80089*16S	88.14 (3.47)	59.94 (2.36)	35.00 (1.38)	0.45 (0.99)
18	18L - M26 x 1.5	DM80089*18L	84.07 (3.31)	59.94 (2.36)	32.00 (1.26)	0.34 (0.75)
20	20S - M30 x 2.0	DM80089*20S	91.95 (3.62)	59.94 (2.36)	38.00 (1.50)	0.52 (1.15)
22	22L - M30 x 2.0	DM80089*22L	87.88 (3.46)	59.94 (2.36)	36.00 (1.42)	0.40 (0.89)
25	25S - M36 x 2.0	DM80089*25S	96.01 (3.78)	59.94 (2.36)	45.00 (1.77)	0.73 (1.61)
28	28L - M36 x 2.0	DM80089*28L	87.88 (3.46)	59.94 (2.36)	40.00 (1.58)	0.45 (1.00)
30	30S - M42 x 2.0	DM80089*30S	99.82 (3.93)	59.94 (2.36)	50.00 (1.97)	0.88 (1.95)
35	35L - M45 x 2.0	DM80089*35L	91.95 (3.62)	59.94 (2.36)	50.00 (1.97)	0.73 (1.62)
38	38S - M52 x 2.0	DM80089*38S	103.89 (4.09)	59.94 (2.36)	60.00 (2.36)	1.26 (2.77)
42	42L - M52 x 2.0	DM80089*42L	91.95 (3.62)	59.94 (2.36)	60.00 (2.36)	1.02 (2.24)

DM 80 Series - Metric Tube

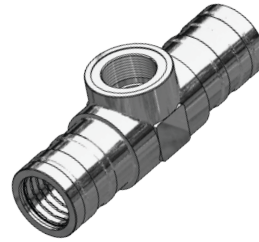
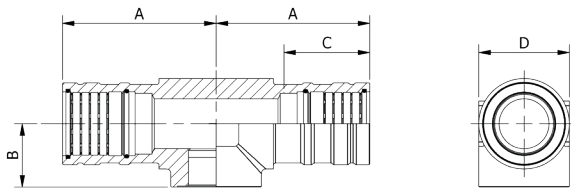

***MATERIAL CODE:**
K = STAINLESS STEEL
G = CARBON STEEL
B = COPPER NICKEL 70/30

ORDER EXAMPLE:
DM80172G1004

BSPF Female Branch Tee, Metric - DM80172

Size OD (mm)	BSPP Size	Part Number	Dimensions - mm (Inch)				*Weight K & G kg (lbs)
			A	B	C Insertion Depth	D	
10	1/4"	DM80172*1004	46.99 (1.85)	20.83 (0.82)	24.13 (0.95)	21.84 (0.86)	0.15 (0.33)
12	1/4"	DM80172*1204	47.75 (1.88)	20.83 (0.82)	26.92 (1.06)	26.92 (1.06)	0.14 (0.30)
15	3/8"	DM80172*1506	52.07 (2.05)	22.35 (0.88)	32.00 (1.26)	26.16 (1.03)	0.27 (0.60)
16	3/8"	DM80172*1606	52.07 (2.05)	22.35 (0.88)	32.00 (1.26)	26.16 (1.03)	0.25 (0.55)
18	3/8"	DM80172*1806	52.07 (2.05)	22.35 (0.88)	35.05 (1.38)	26.16 (1.03)	0.24 (0.52)
20	1/2"	DM80172*2008	73.15 (2.88)	25.40 (1.00)	37.08 (1.46)	33.02 (1.30)	0.38 (0.84)
22	1/2"	DM80172*2208	73.15 (2.88)	25.40 (1.00)	38.10 (1.50)	33.02 (1.30)	0.57 (1.25)
25	3/4"	DM80172*2512	76.92 (3.03)	28.70 (1.13)	41.91 (1.65)	40.13 (1.58)	0.75 (1.60)
28	3/4"	DM80172*2812	76.92 (3.03)	28.70 (1.13)	44.45 (1.75)	40.13 (1.58)	0.71 (1.57)
30	1"	DM80172*3016	85.60 (3.37)	38.10 (1.50)	46.99 (1.85)	50.04 (1.97)	1.22 (2.70)
35	1"	DM80172*3516	85.60 (3.37)	38.10 (1.50)	50.80 (2.00)	50.04 (1.97)	1.27 (2.80)
38	1-1/4"	DM80172*3820	107.95 (4.25)	41.40 (1.63)	54.61 (2.15)	63.50 (2.50)	2.51 (5.53)
42	1-1/4"	DM20172*20	107.95 (4.25)	44.45 (1.75)	60.45 (2.38)	63.50 (2.50)	2.67 (5.89)
50	1-1/2"	DM80172*5024	115.32 (4.54)	44.45 (1.75)	63.50 (2.50)	71.37 (2.81)	3.13 (6.90)
**60K	2"	DM20172K32	138.43 (5.45)	60.45 (2.38)	88.90 (3.50)	82.55 (3.25)	4.75 (10.48)
60G	2"	DM80172G6032	138.43 (5.45)	60.45 (2.38)	88.90 (3.50)	82.55 (3.25)	4.75 (10.48)

**2" DM 20 Series Stainless Steel fittings are also used for 60mm Stainless Steel applications.

DM 80 Series - Metric Tube

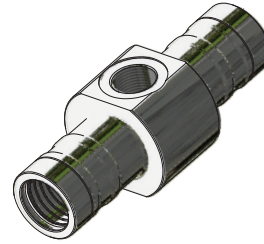
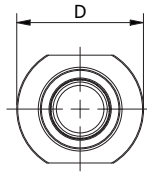
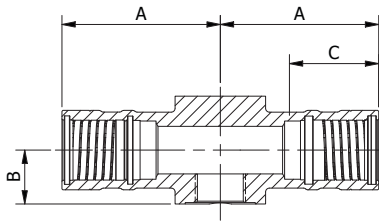

*MATERIAL CODE:
K = STAINLESS STEEL

ORDER EXAMPLE:
DM80211K2004

BSPP Female Branch Tee, Metric - DM80211

Size OD (mm)	BSPP Size	Part Number	Dimensions - mm (Inch)				Weight K kg (lbs)
			A	B	C Insertion Depth	D	
20	1/4"	DM80211K2004	63.50 (2.50)	20.02 (0.79)	37.08 (1.46)	44.45 (1.75)	0.46 (1.02)
20	3/8"	DM80211K2006	50.80 (2.20)	20.02 (0.79)	37.08 (1.46)	47.63 (1.88)	0.52 (1.14)
22	1/4"	DM80211K2204	63.50 (2.50)	20.02 (0.79)	38.10 (1.50)	44.45 (1.75)	0.46 (1.02)
22	3/8"	DM80211K2206	65.08 (2.56)	20.02 (0.79)	38.10 (1.50)	47.63 (1.88)	0.53 (1.16)
25	1/4"	DM80211K2504	63.50 (2.50)	20.02 (0.79)	41.91 (1.65)	44.45 (1.75)	0.55 (1.22)
25	3/8"	DM80211K2506	65.08 (2.56)	20.02 (0.79)	41.91 (1.65)	47.63 (1.88)	0.62 (1.36)
25	1/2"	DM80211K2508	66.68 (2.63)	23.01 (0.91)	41.91 (1.65)	53.98 (2.13)	0.76 (1.67)
28	1/4"	DM80211K2804	66.68 (2.63)	20.02 (0.79)	44.45 (1.75)	44.45 (1.75)	0.58 (1.27)
28	3/8"	DM80211K2806	68.25 (2.69)	21.08 (0.83)	44.45 (1.75)	47.63 (1.88)	0.63 (1.38)
28	1/2"	DM80211K2808	69.85 (2.75)	23.01 (0.91)	44.45 (1.75)	53.98 (2.13)	0.75 (1.66)
30	1/4"	DM80211K3004	71.44 (2.81)	21.44 (0.84)	46.99 (1.85)	47.63 (1.88)	0.78 (1.72)
30	3/8"	DM80211K3006	73.02 (2.88)	21.08 (0.83)	46.99 (1.85)	47.63 (1.88)	0.80 (1.77)
30	1/2"	DM80211K3008	74.63 (2.94)	23.01 (0.91)	46.99 (1.85)	53.98 (2.13)	0.93 (2.05)
35	1/4"	DM80211K3504	72.24 (2.84)	25.40 (1.00)	50.80 (2.00)	53.98 (2.13)	0.85 (1.87)
35	3/8"	DM80211K3506	73.81 (2.91)	24.61 (0.97)	50.80 (2.00)	53.98 (2.13)	0.88 (1.94)
35	1/2"	DM80211K3508	75.41 (2.97)	24.61 (0.97)	50.80 (2.00)	57.15 (2.25)	0.97 (2.13)
38	1/4"	DM80211K3804	80.98 (3.19)	26.19 (1.03)	54.61 (2.15)	57.15 (2.25)	1.32 (2.92)
38	3/8"	DM80211K3806	82.55 (3.25)	26.19 (1.03)	54.61 (2.15)	57.15 (2.25)	1.36 (3.00)
38	1/2"	DM80211K3808	84.15 (3.31)	27.79 (1.09)	54.61 (2.15)	63.50 (2.50)	1.52 (3.35)
42	3/8"	DM20211K2006	82.55 (3.25)	29.36 (1.16)	60.45 (2.38)	63.50 (2.50)	1.53 (3.38)
42	1/2"	DM20211K2008	84.15 (3.31)	28.58 (1.13)	60.45 (2.38)	63.50 (2.50)	1.56 (3.43)
60	3/8"	DM20211K3206	107.95 (4.25)	38.10 (1.50)	88.90 (3.50)	81.28 (3.20)	2.88 (6.35)
60	1/2"	DM20211K3208	139.47 (4.31)	38.10 (1.50)	88.90 (3.50)	81.28 (3.20)	2.95 (6.50)

Note: Only available in Stainless Steel.

DM 80 Series - Metric Tube

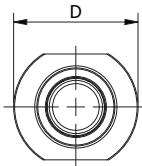
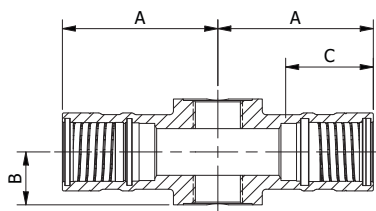

*MATERIAL CODE:
K = STAINLESS STEEL

ORDER EXAMPLE:
DM80221K2004

BSPP (2) Port Female Branch Cross, Metric - DM80221

Size OD (mm)	BSPP Size	Part Number	Dimensions - mm (Inch)				Weight K kg (lbs)
			A	B	C Insertion Depth	D	
20	1/4"	DM80221K2004	63.50 (2.50)	20.02 (0.79)	37.08 (1.46)	44.45 (1.75)	0.45 (1.00)
20	3/8"	DM80221K2006	50.80 (2.20)	20.02 (0.79)	37.08 (1.46)	47.63 (1.88)	0.51 (1.12)
22	1/4"	DM80221K2204	63.50 (2.50)	20.02 (0.79)	38.10 (1.50)	44.45 (1.75)	0.45 (1.00)
22	3/8"	DM80221K2206	65.08 (2.56)	20.02 (0.79)	38.10 (1.50)	47.63 (1.88)	0.51 (1.12)
25	1/4"	DM80221K2504	63.50 (2.50)	20.02 (0.79)	41.91 (1.65)	44.45 (1.75)	0.54 (1.20)
25	3/8"	DM80221K2506	65.08 (2.56)	20.02 (0.79)	41.91 (1.65)	47.63 (1.88)	0.60 (1.32)
25	1/2"	DM80221K2508	66.68 (2.63)	23.01 (0.91)	41.91 (1.65)	53.98 (2.13)	0.72 (1.59)
28	1/4"	DM80221K2804	66.68 (2.63)	20.02 (0.79)	44.45 (1.75)	44.45 (1.75)	0.59 (1.29)
28	3/8"	DM80221K2806	68.25 (2.69)	21.08 (0.83)	44.45 (1.75)	47.63 (1.88)	0.61 (1.34)
28	1/2"	DM80221K2808	69.85 (2.75)	23.01 (0.91)	44.45 (1.75)	53.98 (2.13)	0.72 (1.59)
30	1/4"	DM80221K3004	71.44 (2.81)	21.44 (0.84)	46.99 (1.85)	47.63 (1.88)	0.77 (1.70)
30	3/8"	DM80221K3006	73.02 (2.88)	21.08 (0.83)	46.99 (1.85)	47.63 (1.88)	0.78 (1.73)
30	1/2"	DM80221K3008	74.63 (2.94)	23.01 (0.91)	46.99 (1.85)	53.98 (2.13)	0.90 (1.99)
35	1/4"	DM80221K3504	72.24 (2.84)	25.40 (1.00)	50.80 (2.00)	53.98 (2.13)	0.86 (1.89)
35	3/8"	DM80221K3506	73.81 (2.91)	24.61 (0.97)	50.80 (2.00)	53.98 (2.13)	0.87 (1.92)
35	1/2"	DM80221K3508	75.41 (2.97)	24.61 (0.97)	50.80 (2.00)	57.15 (2.25)	0.94 (2.07)
38	1/4"	DM80221K3804	80.98 (3.19)	26.19 (1.03)	54.61 (2.15)	57.15 (2.25)	1.31 (2.89)
38	3/8"	DM80221K3806	82.55 (3.25)	26.19 (1.03)	54.61 (2.15)	57.15 (2.25)	1.34 (2.96)
38	1/2"	DM80221K3808	84.15 (3.31)	27.79 (1.09)	54.61 (2.15)	63.50 (2.50)	1.49 (3.28)
42	3/8"	DM20221K2006	82.55 (3.25)	29.36 (1.16)	60.45 (2.38)	63.50 (2.50)	1.51 (3.33)
42	1/2"	DM20221K2008	84.15 (3.31)	28.58 (1.13)	60.45 (2.38)	63.50 (2.50)	1.54 (3.39)
60	3/8"	DM20221K3206	107.95 (4.25)	38.10 (1.50)	88.90 (3.50)	81.28 (3.20)	2.86 (6.30)
60	1/2"	DM20221K3208	139.47 (4.31)	38.10 (1.50)	88.90 (3.50)	81.28 (3.20)	2.92 (6.43)

Note: Only available in Stainless Steel.

DM 80 Series - Metric Tube

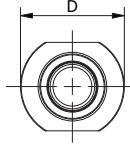
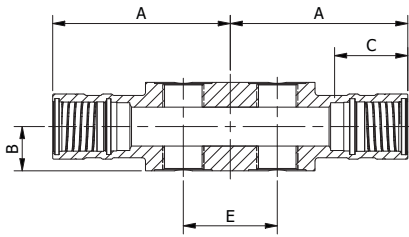

*MATERIAL CODE:
K = STAINLESS STEEL

ORDER EXAMPLE:
DM80241K2004

BSPP (4) Port Female Branch Cross, Metric - DM80241





















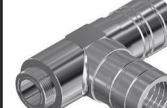







Size OD (mm)	BSPP Size	Part Number	Dimensions - mm (Inch)					Weight K kg (lbs)
			A	B	C Insertion Depth	C	E	
20	1/4"	DM80241K2004	88.90 (3.50)	20.02 (0.79)	37.08 (1.46)	44.45 (1.75)	50.80 (2.00)	0.92 (2.02)
20	3/8"	DM80241K2006	92.08 (3.63)	20.02 (0.79)	37.08 (1.46)	47.63 (1.88)	53.97 (2.13)	1.13 (2.50)
22	1/4"	DM80241K2204	88.90 (3.50)	20.02 (0.79)	38.10 (1.50)	44.45 (1.75)	50.80 (2.00)	1.01 (2.24)
22	3/8"	DM80241K2206	92.08 (3.63)	20.02 (0.79)	38.10 (1.50)	47.63 (1.88)	53.97 (2.13)	1.06 (2.33)
25	1/4"	DM80241K2504	88.90 (3.50)	20.02 (0.79)	41.91 (1.65)	44.45 (1.75)	50.80 (2.00)	1.01 (2.24)
25	3/8"	DM80241K2506	92.08 (3.63)	20.02 (0.79)	41.91 (1.65)	47.63 (1.88)	53.97 (2.13)	1.15 (2.54)
25	1/2"	DM80241K2508	95.25 (3.75)	23.02 (0.91)	41.91 (1.65)	53.98 (2.13)	57.15 (2.25)	1.50 (3.30)
28	1/4"	DM80241K2804	92.08 (3.63)	20.02 (0.79)	44.45 (1.75)	44.45 (1.75)	50.80 (2.00)	1.04 (2.30)
28	3/8"	DM80241K2806	95.25 (3.75)	21.08 (0.83)	44.45 (1.75)	47.63 (1.88)	53.97 (2.13)	1.14 (2.51)
28	1/2"	DM80241K2808	98.43 (3.88)	23.01 (0.91)	44.45 (1.75)	53.98 (2.13)	57.15 (2.25)	1.46 (3.22)
30	1/4"	DM80241K3004	96.82 (3.81)	21.43 (0.84)	46.99 (1.85)	47.63 (1.88)	50.80 (2.00)	1.25 (2.75)
30	3/8"	DM80241K3006	100.02 (3.94)	21.08 (0.83)	46.99 (1.85)	47.63 (1.88)	53.97 (2.13)	1.28 (2.82)
30	1/2"	DM80241K3008	103.20 (4.06)	23.01 (0.91)	46.99 (1.85)	53.98 (2.13)	57.15 (2.25)	1.60 (3.52)
35	1/4"	DM80241K3504	97.64 (3.84)	25.40 (1.00)	50.80 (2.00)	53.98 (2.13)	50.80 (2.00)	1.48 (3.26)
35	3/8"	DM80241K3506	100.81 (3.97)	24.61 (0.97)	50.80 (2.00)	53.98 (2.13)	53.97 (2.13)	1.51 (3.34)
35	1/2"	DM80241K3508	103.99 (4.09)	24.61 (0.97)	50.80 (2.00)	57.15 (2.25)	57.15 (2.25)	1.69 (3.73)
38	1/4"	DM80241K3804	106.38 (4.19)	26.19 (1.03)	54.61 (2.15)	57.15 (2.25)	50.80 (2.00)	1.98 (4.37)
38	3/8"	DM80241K3806	109.55 (4.31)	26.19 (1.03)	54.61 (2.15)	57.15 (2.25)	53.97 (2.13)	2.06 (4.55)
38	1/2"	DM80241K3808	112.73 (4.44)	27.79 (1.09)	54.61 (2.15)	63.50 (2.50)	57.15 (2.25)	2.44 (5.38)
42	3/8"	DM20241K2006	109.55 (4.31)	29.36 (1.16)	60.45 (2.38)	63.50 (2.50)	53.97 (2.13)	2.39 (5.28)
42	1/2"	DM20241K2008	112.73 (4.44)	28.58 (1.13)	60.45 (2.38)	63.50 (2.50)	57.15 (2.25)	2.44 (5.37)
60	3/8"	DM20241K3206	134.95 (5.31)	38.10 (1.50)	88.90 (3.50)	81.28 (3.20)	53.97 (2.13)	4.21 (9.29)
60	1/2"	DM20241K3208	138.13 (5.44)	38.10 (1.50)	88.90 (3.50)	81.28 (3.20)	57.15 (2.25)	4.33 (9.55)

Note: Only available in Stainless Steel.

Specialty Fitting Configuration Guide

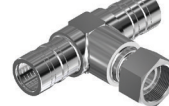
DM 80 Series - Metric Tube

6mm to 60mm

					
JIC 37° 90° Elbow Male DM80355	JIC 37° Branch Tee Male DM80177	JIC 37° Run Tee Male DM80178	JIC 37° 90° Elbow Female Swivel DM80354	JIC 37° Branch Tee Female Swivel DM80170	NPT 90° Elbow Male DM80057
					
NPT Branch Tee Male DM80176	NPT Run Tee Male DM80181	NPT 90° Elbow Female DM80061	ORFS 90° Elbow Male DM80011	ORFS Branch Tee Male DM80013	ORFS Run Tee Male DM80014
					
ORFS 90° Elbow Female Swivel DM80021	ORFS Branch Tee Female Swivel DM80023	SAE 90° Elbow Male DM80105	SAE Branch Tee Male DM80174	SAE Run Tee Male DM80179	SAE 90° Elbow Female DM80387
					
BSPP 90° Elbow Male DM80168	BSPP Branch Tee Male DM80175	BSPP Run Tee Male DM80180	BSPP 90° Elbow Female DM80169	DIN 24° 90° Elbow Male DM80073	DIN 24° Branch Tee Male DM80182
					
DIN 24° Run Tee Male DM80183	DIN 24° 90° Elbow Female Swivel DM80069	DIN 24° Branch Tee Female Swivel DM80184	Compact Elbow x Code 61 Flange DM80231	Compact Elbow x Code 62 Flange DM80232	90° PYPLOK® x SAE Code 61 Flange DM80391

Specialty Fitting Configuration Guide

DM 80 Series - Metric Tube

6mm to 60mm



**90° PYLOK® x
SAE Code 62
Flange**
DM80392



**NPS to Metric
Tube Reducer**
DM20801



**Extra Long
Coupling**
DM80301

Introduction

Technical
Information

DM 20 –
NPS Pipe

DM 60 –
OD Tube

DM 80 – Metric
& JIS Tube

DP 40N – NPS
Low Pressure

DP 40M – Metric
Low Pressure

PYPLOK®
Tooling

Installation
Procedures

Appendix

General Characteristics

DM 80 Series - JIS Metric Tube

Fitting Material Specifications Material Specification

K = Stainless Steel	ASTM-A479/A182-316
G = Carbon Steel	ASTM-A105/A350 LF2
B = Copper Nickel 70/30	MIL-C71500
C = Copper Nickel 90/10	MIL-C70600
D = Duplex	ASTM-A479/A182-UNS31803
Z = Super Duplex	ASTM-A479/A182-UNS32750

O-Ring Material Specifications O-Ring Temperature Limits

VITON (Brown Colour)	-15°F to 400°F (-26°C to 205°C)
EPDM (Black Colour)	-60°F to 400°F (-51°C to 205°C)

For seal compatibility and selection for each system consult factory. Other seal materials for specific applications of compatibility and temperature are available upon request.

Ordering Information

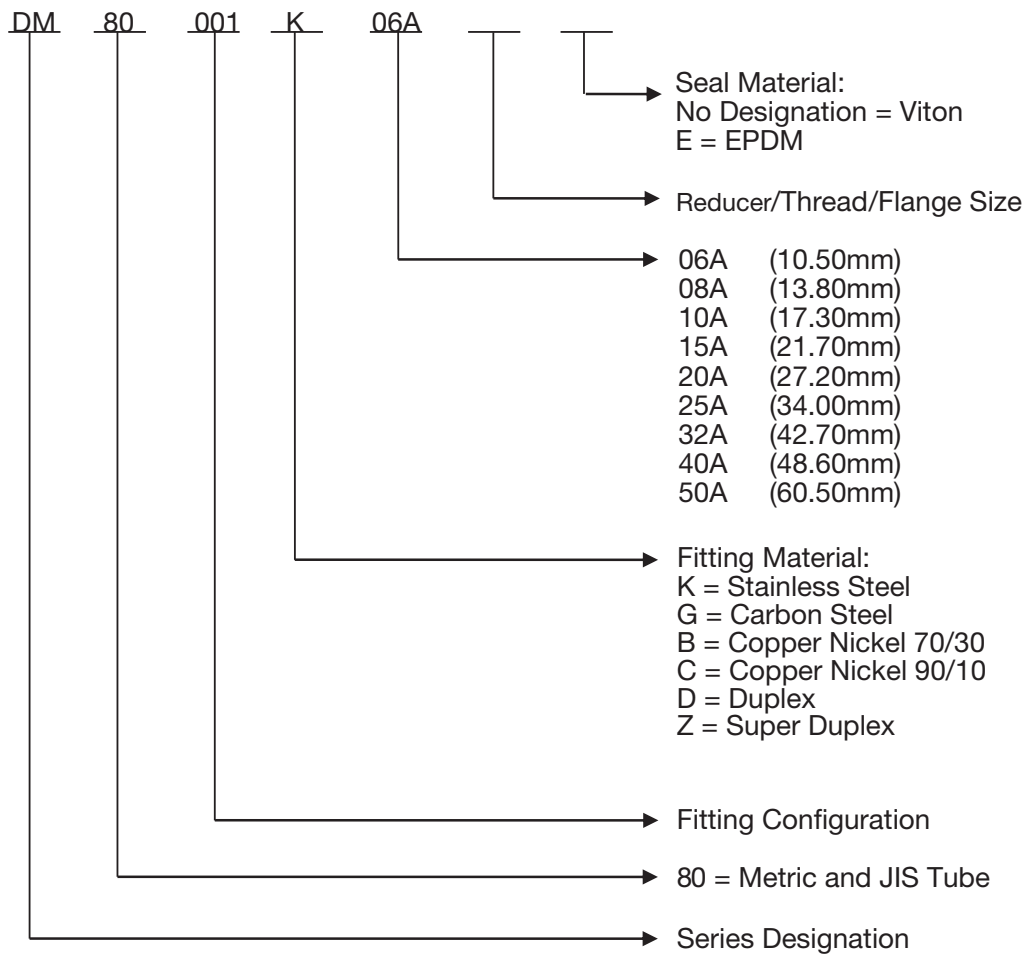

System design and safe application is the responsibility of the end-user. Consideration must be taken to confirm proper fitting selection is made to ensure proper compatibility, function and operation of the fitting within the piping system. The technical and performance information such as weights, dimensions and ratings in this catalogue supersede all previous published data. Tube-Mac® reserves the right to change technical data and product dimension, ratings and other aspects without notice.

Standard Fitting Configuration Guide

DM 80 Series - JIS Metric Tube

06A to 50A



Coupling
DM80001
Page E27

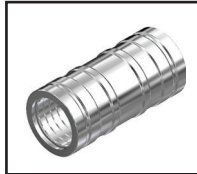

**Coupling with
Inner Stop**
DM80002
Page E27



90° Elbow
DM80003
Page E28

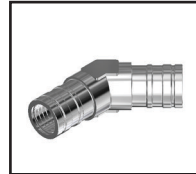

45° Elbow
DM80017
Page E28

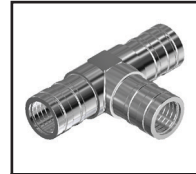

Tee
DM80004
Page E29



End Cap
DM80085
Page E29

DM 80 Series - JIS Metric Tube

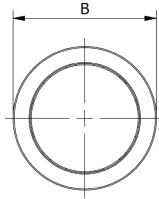
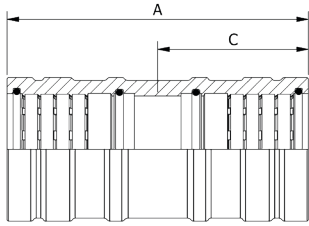

***MATERIAL CODE:**
 K = STAINLESS STEEL
 G = CARBON STEEL
 B = COPPER NICKEL 70/30

ORDER EXAMPLE:
 DM80001G06A

Coupling, Metric, JIS - DM80001

JIS Size	Part Number	Dimensions - mm (Inch)			*Weight K & G kg (lbs)
		A	B	C Insertion Depth	
06A	DM80001*06A	48.30 (1.90)	15.09 (0.59)	24.13 (0.95)	0.03 (0.06)
08A	DM80001*08A	54.00 (2.13)	18.59 (0.73)	27.00 (1.06)	0.05 (0.10)
10A	DM80001*10A	64.01 (2.52)	23.70 (0.93)	32.00 (1.26)	0.09 (0.19)
15A	DM80001*15A	74.17 (2.91)	28.70 (1.13)	37.08 (1.46)	0.15 (0.32)
20A	DM80001*20A	84.07 (3.31)	35.31 (1.39)	41.91 (1.65)	0.24 (0.53)
25A	DM80001*25A	93.98 (3.70)	41.91 (1.65)	46.99 (1.85)	0.39 (0.85)
32A	DM80001*32A	120.65 (4.75)	57.40 (2.26)	60.45 (2.38)	0.89 (1.96)
40A	DM80001*40A	127.00 (5.00)	65.53 (2.58)	63.50 (2.50)	1.26 (2.78)
50A	DM80001*50A	177.80 (7.00)	77.22 (3.04)	88.90 (3.50)	2.00 (4.40)

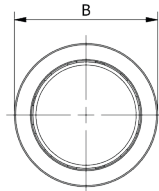
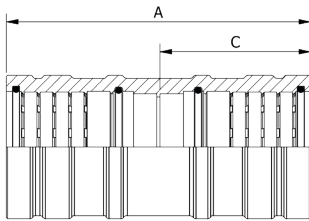

***MATERIAL CODE:**
 K = STAINLESS STEEL
 G = CARBON STEEL
 B = COPPER NICKEL 70/30

ORDER EXAMPLE:
 DM80002G06A

Coupling with Inner Stop, Metric, JIS - DM80002

JIS Size	Part Number	Dimensions - mm (Inch)			*Weight K & G kg (lbs)
		A	B	C Insertion Depth	
06A	DM80002*06A	49.53 (1.95)	15.09 (0.59)	24.13 (0.95)	0.06 (0.03)
08A	DM80002*08A	55.37 (2.18)	18.59 (0.73)	26.92 (1.06)	0.05 (0.10)
10A	DM80002*10A	65.28 (2.57)	23.70 (0.93)	32.00 (1.26)	0.09 (0.20)
15A	DM80002*15A	75.44 (2.97)	28.70 (1.13)	37.08 (1.46)	0.15 (0.32)
20A	DM80002*20A	85.34 (3.36)	35.31 (1.39)	41.91 (1.65)	0.24 (0.54)
25A	DM80002*25A	95.25 (3.75)	41.91 (1.65)	46.99 (1.85)	0.39 (0.85)
32A	DM80002*32A	121.92 (4.80)	57.40 (2.26)	60.45 (2.38)	0.89 (1.96)
40A	DM80002*40A	128.27 (5.05)	65.53 (2.58)	63.50 (2.50)	1.26 (2.78)
50A	DM80002*50A	179.07 (7.05)	77.22 (3.04)	88.90 (3.50)	2.00 (4.40)

3D step models available upon request

DM 80 Series - JIS Metric Tube

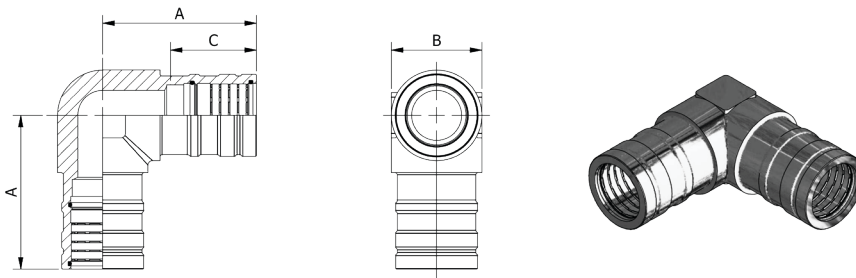

***MATERIAL CODE:**
 K = STAINLESS STEEL
 G = CARBON STEEL
 B = COPPER NICKEL 70/30

ORDER EXAMPLE:
 DM80003G06A

90° Elbow, Metric, JIS - DM80003

JIS Size	Part Number	Dimensions - mm (Inch)			*Weight K & G kg (lbs)
		A	B	C Insertion Depth	
06A	DM80003*06A	42.67 (1.68)	21.84 (0.86)	24.13 (0.95)	0.08 (0.18)
08A	DM80003*08A	45.29 (1.78)	21.84 (0.86)	26.92 (1.06)	0.09 (0.20)
10A	DM80003*10A	52.07 (2.05)	26.92 (1.06)	32.00 (1.26)	0.20 (0.43)
15A	DM80003*15A	73.15 (2.88)	33.02 (1.30)	37.08 (1.46)	0.36 (0.80)
20A	DM80003*20A	76.96 (3.03)	40.13 (1.58)	41.91 (1.65)	0.58 (1.27)
25A	DM80003*25A	85.60 (3.37)	50.04 (1.97)	46.99 (1.85)	1.13 (2.50)
32A	DM80003*32A	107.95 (4.25)	63.50 (2.50)	60.45 (2.38)	2.70 (5.95)
40A	DM80003*40A	115.32 (4.54)	71.37 (2.81)	63.50 (2.50)	3.22 (7.10)
50A	DM80003*50A	138.43 (5.45)	82.55 (3.25)	88.90 (3.50)	4.40 (9.70)

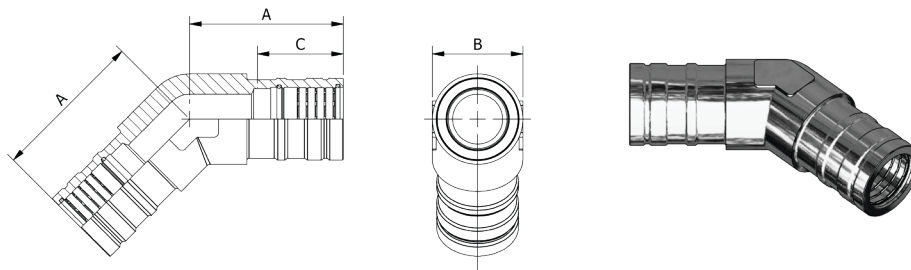

***MATERIAL CODE:**
 K = STAINLESS STEEL
 G = CARBON STEEL
 B = COPPER NICKEL 70/30

ORDER EXAMPLE:
 DM80017G06A

45° Elbow, Metric, JIS - DM80017

JIS Size	Part Number	Dimensions - mm (Inch)			*Weight K & G kg (lbs)
		A	B	C Insertion Depth	
06A	DM80017*06A	42.67 (1.68)	21.84 (0.86)	24.13 (0.95)	0.09 (0.19)
08A	DM80017*08A	45.21 (1.78)	21.84 (0.86)	26.92 (1.06)	0.13 (0.29)
10A	DM80017*10A	52.07 (2.05)	26.92 (1.06)	32.00 (1.26)	0.23 (0.50)
15A	DM80017*15A	73.15 (2.88)	33.02 (1.30)	37.08 (1.46)	0.46 (1.02)
20A	DM80017*20A	76.96 (3.03)	40.13 (1.58)	41.91 (1.65)	0.72 (1.59)
25A	DM80017*25A	85.60 (3.37)	50.04 (1.97)	46.99 (1.85)	1.22 (2.68)
32A	DM80017*32A	107.95 (4.25)	63.50 (2.50)	60.45 (2.38)	2.54 (5.60)
40A	DM80017*40A	115.32 (4.54)	71.37 (2.81)	63.50 (2.50)	3.36 (7.40)
50A	DM80017*50A	138.43 (5.45)	82.55 (3.25)	88.90 (3.50)	4.35 (9.60)

3D step models available upon request

DM 80 Series - JIS Metric Tube

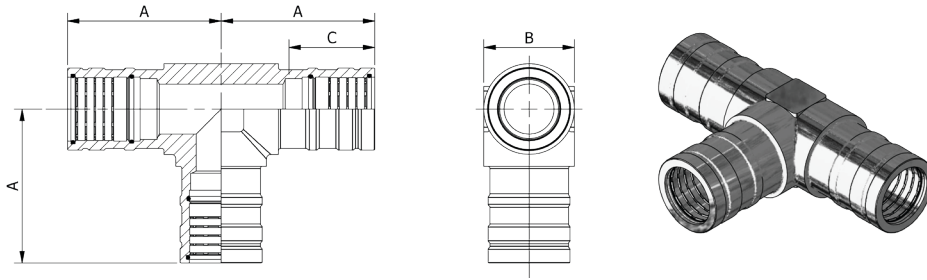

*MATERIAL CODE:
 K = STAINLESS STEEL
 G = CARBON STEEL
 B = COPPER NICKEL 70/30

ORDER EXAMPLE:
 DM80004G06A

Tee, Metric, JIS - DM80004

JIS Size	Part Number	Dimensions - mm (Inch)			*Weight K & G kg (lbs)
		A	B	C Insertion Depth	
06A	DM80004*06A	42.67 (1.68)	21.84 (0.86)	24.13 (0.95)	0.09 (0.20)
08A	DM80004*08A	45.21 (1.78)	21.84 (0.86)	26.92 (1.06)	0.15 (0.34)
10A	DM80004*10A	52.07 (2.05)	26.92 (1.06)	32.00 (1.26)	0.29 (0.65)
15A	DM80004*15A	73.15 (2.88)	33.02 (1.30)	37.08 (1.46)	0.59 (1.30)
20A	DM80004*20A	76.96 (3.03)	40.13 (1.58)	41.91 (1.65)	0.91 (2.01)
25A	DM80004*25A	85.60 (3.37)	50.04 (1.97)	46.99 (1.85)	1.46 (3.22)
32A	DM80004*32A	107.95 (4.25)	63.50 (2.50)	60.45 (2.38)	3.22 (7.10)
40A	DM80004*40A	115.32 (4.54)	71.37 (2.81)	63.50 (2.50)	4.17 (9.20)
50A	DM80004*50A	138.43 (5.45)	82.55 (3.25)	88.90 (3.50)	5.55 (12.20)

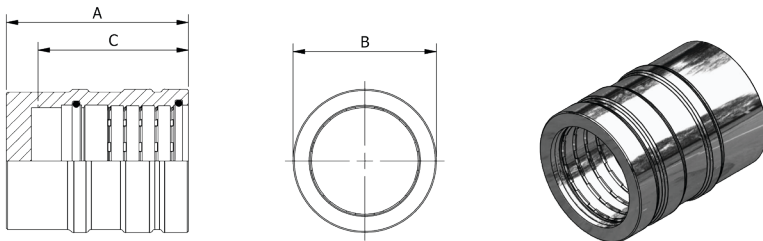

*MATERIAL CODE:
 K = STAINLESS STEEL
 G = CARBON STEEL
 B = COPPER NICKEL 70/30

ORDER EXAMPLE:
 DM80085G06A

End Cap, Metric, JIS - DM80085









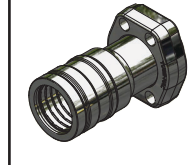
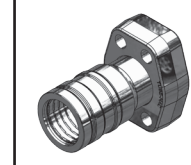
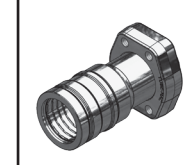
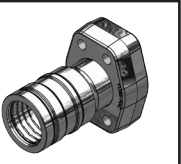

JIS Size	Part Number	Dimensions - mm (Inch)			*Weight K & G kg (lbs)
		A	B	C Insertion Depth	
06A	DM80085*06A	33.78 (1.33)	15.09 (0.59)	24.13 (0.95)	0.02 (0.05)
08A	DM80085*08A	37.59 (1.48)	18.59 (0.73)	26.92 (1.06)	0.04 (0.08)
10A	DM80085*10A	45.72 (1.80)	23.70 (0.93)	32.00 (1.26)	0.08 (0.17)
15A	DM80085*15A	55.63 (2.19)	28.70 (1.13)	37.08 (1.46)	0.14 (0.31)
20A	DM80085*20A	60.71 (2.39)	35.31 (1.39)	41.91 (1.65)	0.23 (0.50)
25A	DM80085*25A	65.53 (2.58)	41.91 (1.65)	46.99 (1.85)	0.34 (0.76)
32A	DM80085*32A	73.15 (2.88)	57.40 (2.26)	60.45 (2.38)	0.65 (1.44)
40A	DM80085*40A	76.20 (3.00)	65.53 (2.58)	63.50 (2.50)	0.90 (1.20)
50A	DM80085*50A	104.90 (4.13)	77.22 (3.04)	88.90 (3.50)	1.42 (3.13)

3D step models available upon request

Specialty Fitting Configuration Guide

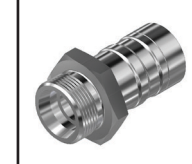
DM 80 Series - JIS Metric Tube

06A to 50A

					
Reducer DM80101	SAE Flange Body DM80090	Reducing Tee DM80104	ISO 6162-1 Flange DM80091	ISO 6162-2 Flange DM80092	ISO 6162-1 Tapped Flange DM80095
					
ISO 6162-2 Tapped Flange DM80096	JIC 37° Male DM80055	JIC 37° Female Swivel DM80054	BSPP Male DM80153	BSPP Female DM80086	DIN 24° Male DM80066
					
DIN 24° Female Swivel DM80068	Weldable Bulkhead DM80089	BSPP Female Branch Tee DM80172			

General Characteristics

DP 40N Series – NPS Low Pressure

Fitting Material Specifications

K = Stainless Steel
 G = Carbon Steel
 B = Copper Nickel 70/30
 C = Copper Nickel 90/10

Material Specification

ASTM-A479/A182-316
 ASTM-A105/A350 LF2
 MIL-C71500
 MIL-C70600

PYPLOK® DP 40 Series shapes such as Tees, Elbows and ANSI Flanged End are made as welded assemblies using ASME B16.9 SCH.40 Butt Weld Fitting with the following material specification:

K = Stainless Steel
 G = Carbon Steel

ASTM-A312
 ASTM-A105

O-Ring Material Specifications

VITON (Brown Colour)
 EPDM (Black Colour)

O-Ring Temperature Limits

-15°F to 400°F (-26°C to 205°C)
 -60°F to 400°F (-51°C to 205°C)

For seal compatibility and selection for each system consult factory. Other seal materials for specific applications of compatibility and temperature are available upon request.

Ordering Information

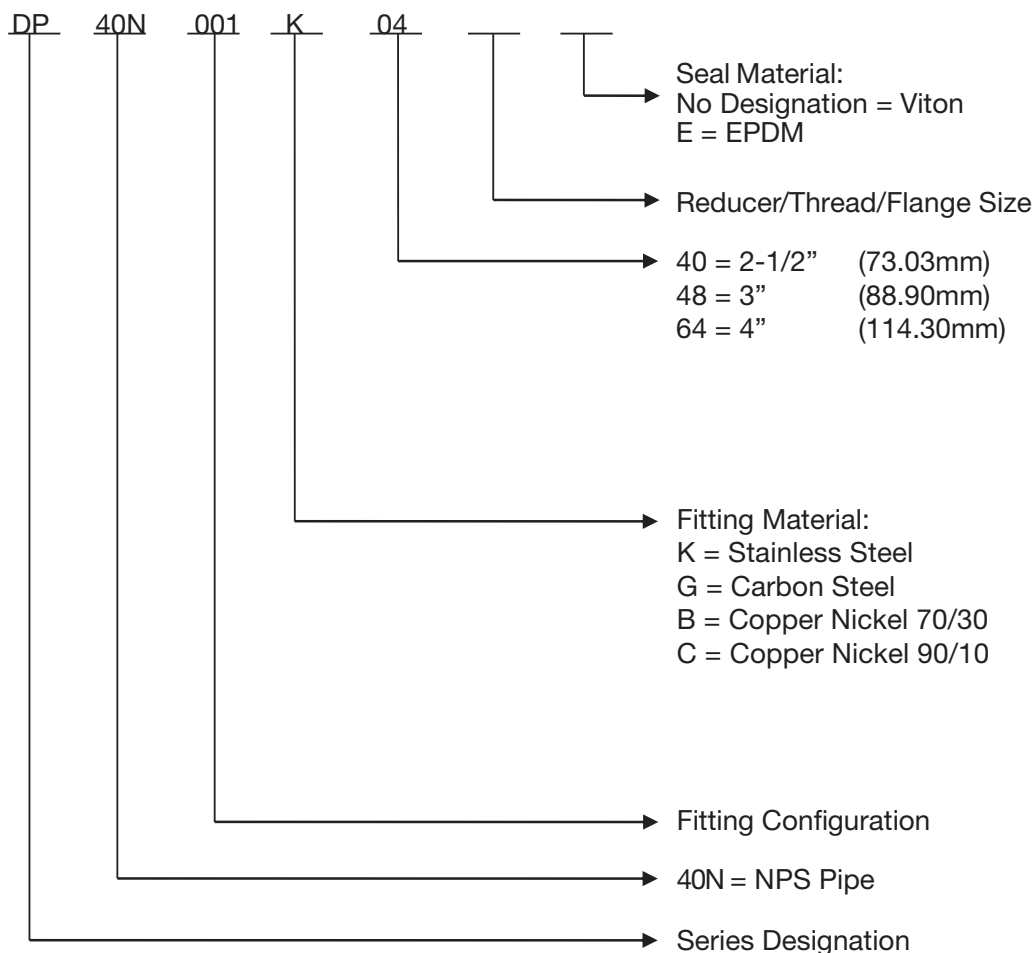

System design and safe application is the responsibility of the end-user. Consideration must be taken to confirm proper fitting selection is made to ensure proper compatibility, function and operation of the fitting within the piping system. The technical and performance information such as weights, dimensions and ratings in this catalogue supersede all previous published data. Tube-Mac® reserves the right to change technical data and product dimension, ratings and other aspects without notice.

Standard Fitting Configuration Guide

DP 40N Series - NPS Low Pressure

2-1/2" to 4"



Low Pressure Coupling
DP40N100
Page F3



Low Pressure 90° Elbow
DP40N300
Page F3

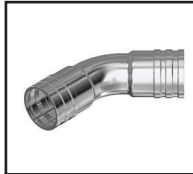

Low Pressure 45° Elbow
DP40N017
Page F4

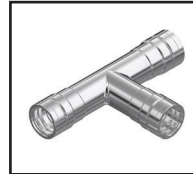

Low Pressure Tee
DP40N400
Page F4

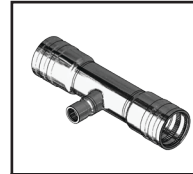

Low Pressure Reducing Tee
DP40N104
Page F5



Low Pressure Reducer
DP40N101
Page F5



Low Pressure End Cap
DP40N085
Page F6



Low Pressure Flange - 150#
DP40N018
Page F6



Low Pressure SAE Code 61 Flange
DP40N091
Page F7



Low Pressure SAE Code 61 Tapped Flange
DP40N095
Page F7

DP 40N Series – NPS Low Pressure

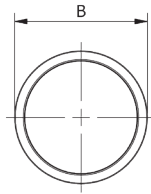
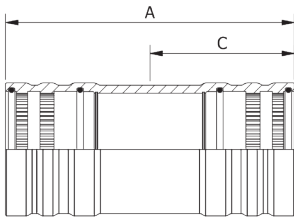

***MATERIAL CODE:**
 K = STAINLESS STEEL
 G = CARBON STEEL
 B = COPPER NICKEL 70/30

ORDER EXAMPLE:
 DP40N100G40

Low Pressure Coupling, NPS - DP40N100

Size NPS	Part Number	Dimensions - Inch (mm)			*Weight K & G lbs (kg)
		A	B	C Insertion Depth	
2-1/2"	DP40N100*40	7.50 (190.50)	3.45 (87.63)	3.75 (95.25)	4.38 (1.99)
3"	DP40N100*48	8.70 (220.98)	4.14 (105.16)	4.35 (110.49)	6.68 (3.03)
4"	DP40N100*64	13.50 (342.90)	5.32 (135.13)	6.75 (171.45)	18.63 (8.45)

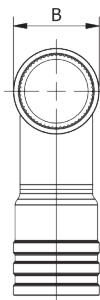
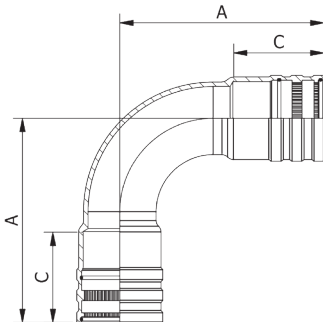

***MATERIAL CODE:**
 K = STAINLESS STEEL
 G = CARBON STEEL
 B = COPPER NICKEL 70/30

ORDER EXAMPLE:
 DP40N300G40

Low Pressure 90° Elbow, NPS - DP40N300

Size NPS	Part Number	Dimensions - Inch (mm)			*Weight K & G lbs (kg)
		A	B	C Insertion Depth	
2-1/2"	DP40N300*40	8.53 (216.66)	3.45 (87.63)	3.75 (95.25)	8.35 (3.79)
3"	DP40N300*48	9.71 (246.63)	4.14 (105.16)	4.35 (110.49)	12.57 (5.70)
4"	DP40N300*64	14.13 (358.90)	5.32 (135.13)	6.75 (171.45)	30.60 (13.88)

PYPLOK® DP 40 Series shapes such as Tees, Elbows and ANSI Flanged Ends are made as welded assemblies using ASME B16.9 SCH.40 Butt Weld Fittings.

DP 40N Series – NPS Low Pressure

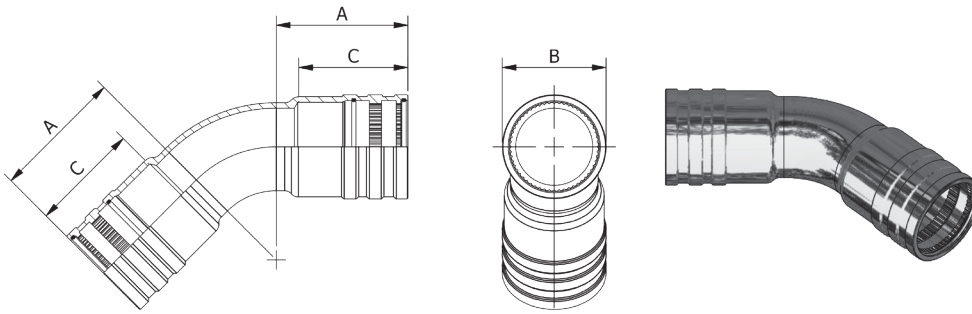

***MATERIAL CODE:**
 K = STAINLESS STEEL
 G = CARBON STEEL
 B = COPPER NICKEL 70/30

ORDER EXAMPLE:
 DP40N017G40

Low Pressure 45° Elbow, NPS - DP40N017

Size NPS	Part Number	Dimensions - Inch (mm)			*Weight K & G lbs (kg)
		A	B	C Insertion Depth	
2-1/2"	DP40N017*40	6.53 (165.86)	3.45 (87.63)	3.75 (95.25)	2.71 (1.23)
3"	DP40N017*48	7.20 (182.88)	4.14 (105.16)	4.35 (110.49)	10.10 (4.58)
4"	DP40N017*64	10.61 (269.49)	5.32 (135.13)	6.75 (171.45)	26.28 (11.92)

PYPLOK® DP 40 Series shapes such Tees, Elbows and ANSI Flanged Ends are made as welded assemblies using ASME B16.9 SCH.40 Butt Weld Fittings.

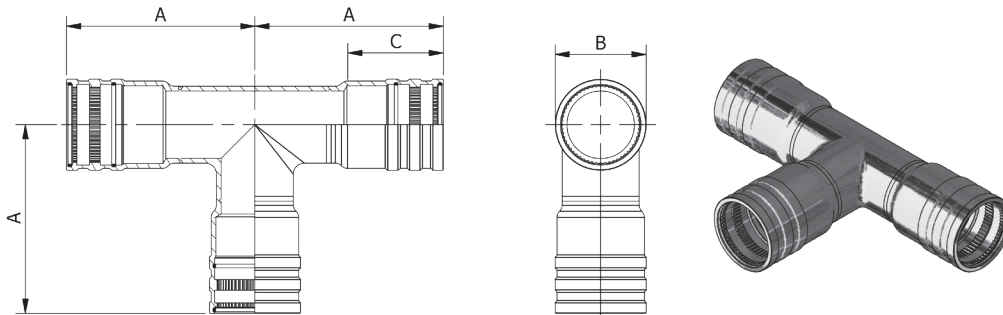

***MATERIAL CODE:**
 K = STAINLESS STEEL
 G = CARBON STEEL
 B = COPPER NICKEL 70/30

ORDER EXAMPLE:
 DP40N400G40

Low Pressure Tee, NPS - DP40N400

Size NPS	Part Number	Dimensions - Inch (mm)			*Weight K & G lbs (kg)
		A	B	C Insertion Depth	
2-1/2"	DP40N400*40	7.78 (197.61)	3.45 (87.63)	3.75 (95.25)	12.80 (5.81)
3"	DP40N400*48	8.58 (217.93)	4.14 (105.16)	4.35 (110.49)	18.10 (8.21)
4"	DP40N400*64	12.25 (311.15)	5.32 (135.13)	6.75 (171.45)	42.12 (19.11)

PYPLOK® DP 40 Series shapes such Tees, Elbows and ANSI Flanged Ends are made as welded assemblies using ASME B16.9 SCH.40 Butt Weld Fittings.

DP 40N Series – NPS Low Pressure

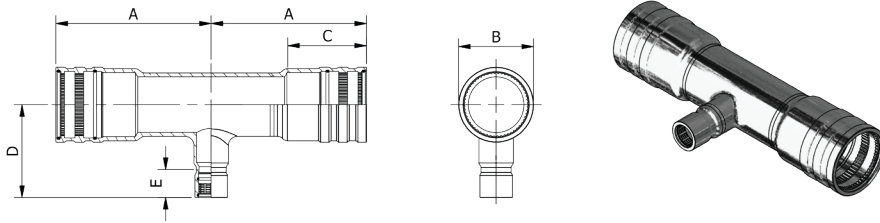

***MATERIAL CODE:**
 K = STAINLESS STEEL
 G = CARBON STEEL
 B = COPPER NICKEL 70/30

ORDER EXAMPLE:
 DP40N104G4032

Low Pressure Reducing Tee, NPS - DP40N104

Port 1 Size NPS	Port 2 Size NPS	Part Number	Dimensions - Inch (mm)					*Weight K & G lbs (kg)
			A	B	C Insertion Depth	D	E Insertion Depth	
2-1/2"	2"	DP40N104*4032	7.78 (197.61)	3.45 (87.63)	3.75 (95.25)	7.48 (189.99)	3.50 (88.90)	11.65 (5.28)
3"	2"	DP40N104*4832	8.58 (217.93)	4.14 (105.16)	4.35 (110.49)	7.76 (197.10)	3.50 (88.90)	15.57 (7.06)
3"	2-1/2"	DP40N104*4840	8.58 (217.93)	4.14 (105.16)	4.35 (110.49)	8.03 (203.96)	3.75 (95.25)	15.72 (7.13)
4"	3"	DP40N104*6448	12.25 (311.15)	5.32 (135.13)	6.75 (171.45)	9.09 (230.89)	4.35 (110.49)	34.60 (15.69)

PYPLOK® DP 40 Series shapes such Tees, Elbows and ANSI Flanged Ends are made as welded assemblies using ASME B16.9 SCH.40 Butt Weld Fittings.

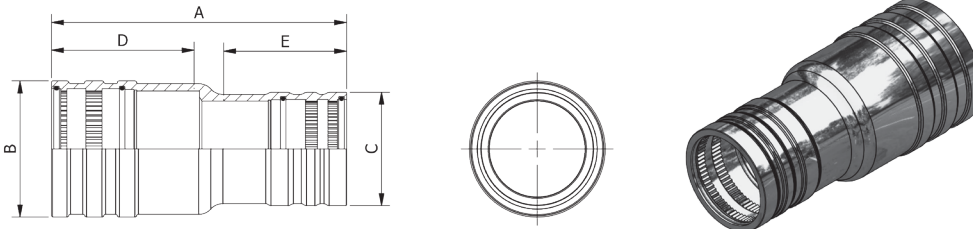

***MATERIAL CODE:**
 K = STAINLESS STEEL
 G = CARBON STEEL
 B = COPPER NICKEL 70/30

ORDER EXAMPLE:
 DP40N101G4024

Other configurations available.
 Contact factory for details.

Low Pressure Reducer, NPS - DP40N101

End 1 Size NPS	End 2 Size NPS	Part Number	Dimensions - mm (Inch)					*Weight K & G lbs (kg)
			A	B	C	D Insertion Depth	E Insertion Depth	
2-1/2"	1-1/2"	DP40N101*4024	8.00 (203.20)	3.45 (87.63)	2.58 (65.53)	3.75 (95.25)	2.50 (63.50)	5.50 (2.49)
2-1/2"	2"	DP40N101*4032	8.25 (209.55)	3.45 (87.63)	3.04 (77.22)	3.75 (95.25)	3.50 (88.90)	5.42 (2.46)
3"	2"	DP40N101*4832	9.00 (228.60)	4.14 (105.16)	3.04 (77.22)	4.35 (110.49)	3.50 (88.90)	7.21 (3.27)
3"	2-1/2"	DP40N101*4840	9.00 (228.60)	4.14 (105.16)	3.45 (87.63)	4.35 (110.49)	3.75 (95.25)	6.48 (2.94)
4"	3"	DP40N101*6448	13.00 (330.20)	5.35 (135.13)	4.14 (105.16)	6.75 (171.45)	4.35 (110.49)	16.10 (7.30)

DP 40N Series – NPS Low Pressure

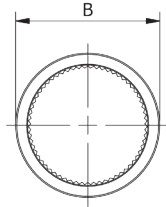
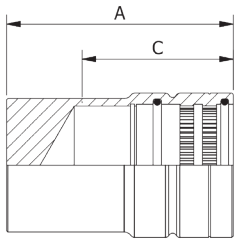

***MATERIAL CODE:**
 K = STAINLESS STEEL
 G = CARBON STEEL
 B = COPPER NICKEL 70/30

ORDER EXAMPLE:
 DP40N085G40

Low Pressure End Cap, NPS - DP40N085

Size NPS	Part Number	Dimensions - Inch (mm)			*Weight K & G lbs (kg)
		A	B	C Insertion Depth	
2-1/2"	DP40N085*40	4.50 (114.30)	3.45 (87.63)	3.75 (95.25)	3.66 (1.66)
3"	DP40N085*48	5.23 (129.54)	4.14 (105.16)	4.35 (110.49)	5.49 (2.49)
4"	DP40N085*64	7.63 (190.50)	5.32 (135.13)	6.75 (171.45)	12.57 (5.70)

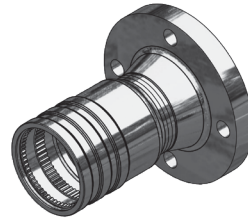
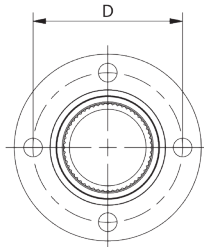
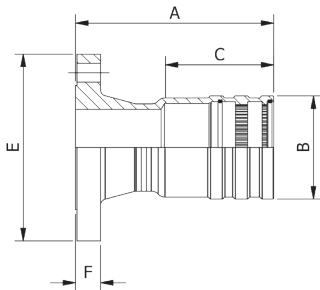

***MATERIAL CODE:**
 K = STAINLESS STEEL
 G = CARBON STEEL
 B = COPPER NICKEL 70/30

ORDER EXAMPLE:
 DP40N018G40

Low Pressure Flange – ANSI 150#, NPS - DP40N018

Size NPS	Flange Size	Part Number	Dimensions - mm (Inch)						Bolt Size	*Weight K & G lbs (kg)
			A	B	C Insertion Depth	D	E	F		
2-1/2"	2-1/2"	DP40N018*40	7.53 (191.26)	3.45 (87.63)	3.75 (95.25)	5.50 (139.70)	7.00 (177.80)	0.94 (23.88)	5/8" UNC	12.73 (5.77)
3"	3"	DP40N018*48	7.96 (202.18)	4.14 (105.16)	4.35 (110.49)	6.00 (152.40)	7.50 (190.50)	0.94 (23.88)	5/8" UNC	19.26 (8.74)
4"	4"	DP40N018*64	11.10 (281.94)	5.32 (135.13)	6.75 (171.45)	7.50 (190.50)	9.00 (228.60)	1.19 (30.23)	5/8" UNC	27.33 (12.40)

PYPLOK® DP 40 Series shapes such as Tees, Elbows and ANSI Flanged Ends are made as welded assemblies using ASME B16.9 SCH.40 Butt Weld Fittings.

DP 40N Series – NPS Low Pressure

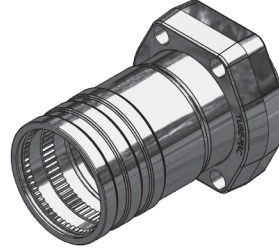
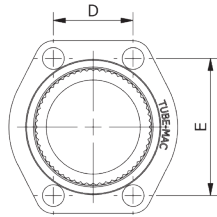
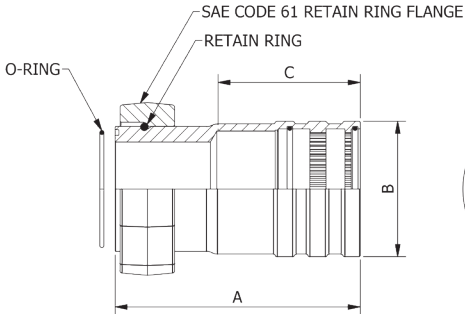

***MATERIAL CODE:**
 K = STAINLESS STEEL
 G = CARBON STEEL
 B = COPPER NICKEL 70/30

ORDER EXAMPLE:
 DP40N091G40

Low Pressure SAE Code 61 Flange, NPS - DP40N091

Size NPS	Flange Size	Part Number	Dimensions - Inch (mm)					Bolt Minimum Grade 8	*Weight K & G lbs (kg)
			A	B	C Insertion Depth	D	E		
2-1/2"	2-1/2"	DP40N091*40	7.00 (177.80)	3.45 (87.63)	3.75 (95.25)	2.00 (50.80)	3.49 (88.65)	1/2" UNC	8.41 (3.81)
3"	3"	DP40N091*48	7.50 (190.50)	4.14 (105.16)	4.35 (110.49)	2.44 (61.98)	4.19 (106.43)	5/8" UNC	12.40 (5.62)
4"	4"	DP40N091*64	11.00 (279.40)	5.32 (135.13)	6.75 (171.45)	3.06 (77.72)	5.13 (130.30)	5/8" UNC	22.65 (10.27)

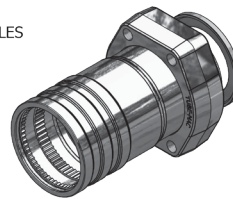
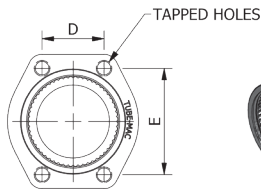
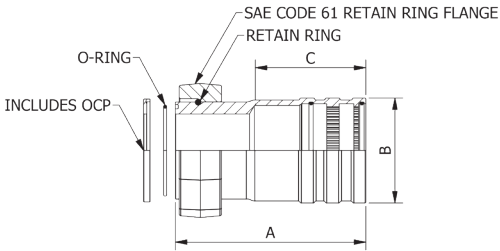

***MATERIAL CODE:**
 K = STAINLESS STEEL
 G = CARBON STEEL
 B = COPPER NICKEL 70/30

ORDER EXAMPLE:
 DP40N095G40

Low Pressure SAE Code 61 Tapped Flange, NPS - DP40N095

Size NPS	Flange Size	Part Number	Dimensions - Inch (mm)					Tap UNC-2B	*Weight K & G lbs (kg)
			A	B	C Insertion Depth	D	E		
2-1/2"	2-1/2"	DP40N095*40	7.00 (177.80)	3.45 (87.63)	3.75 (95.25)	2.00 (50.80)	3.49 (88.65)	1/2"-13	8.41 (3.81)
3"	3"	DP40N095*48	7.50 (190.50)	4.14 (105.16)	4.35 (110.49)	2.44 (61.98)	4.19 (106.43)	5/8"-11	12.40 (5.62)
4"	4"	DP40N095*64	11.00 (279.40)	5.32 (135.13)	6.75 (171.45)	3.06 (77.72)	5.13 (130.30)	5/8"-11	22.65 (10.27)

General Characteristics

DP 40M Series - Metric Low Pressure

Fitting Material Specifications

B = Copper Nickel 70/30
C = Copper Nickel 90/10

Material Specification

MIL-C71500
MIL-C70600

PYPLOK® DP 40M Series shapes such as Tees, Elbows and ANSI Flanged End are made as welded assemblies using ASME B16.9 CL 200 Butt Weld Fitting.

O-Ring Material Specifications

VITON (Brown Colour)
EPDM (Black Colour)

O-Ring Temperature Limits

-15°F to 400°F (-26°C to 205°C)
-60°F to 400°F (-51°C to 205°C)

For seal compatibility and selection for each system consult factory. Other seal materials for specific applications of compatibility and temperature are available upon request.

Ordering Information

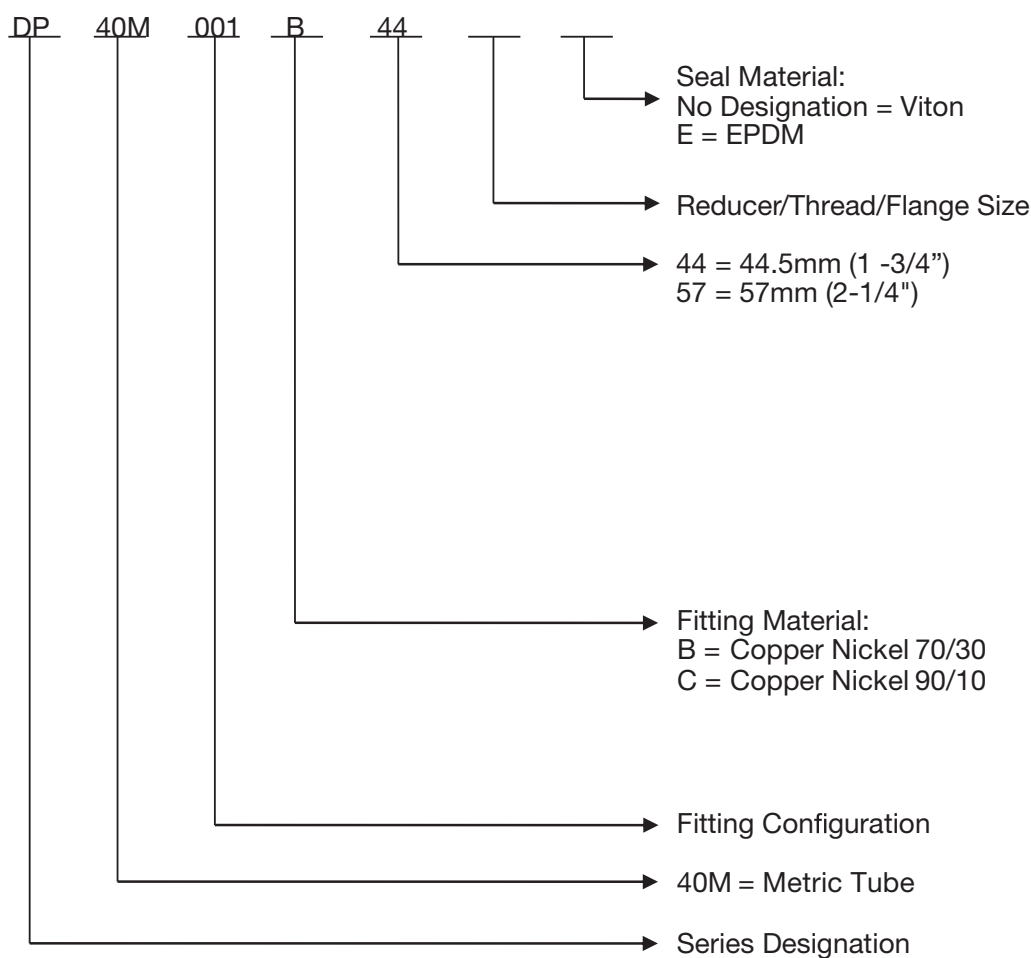

System design and safe application is the responsibility of the end-user. Consideration must be taken to confirm proper fitting selection is made to ensure proper compatibility, function and operation of the fitting within the piping system. The technical and performance information such as weights, dimensions and ratings in this catalogue supersede all previous published data. Tube-Mac® reserves the right to change technical data and product dimension, ratings and other aspects without notice.

Standard Fitting Configuration Guide

DP 40M Series - Metric Low Pressure

44mm to 57mm



Coupling
DP40M100
Page G3



90° Elbow
DP40M300
Page G3

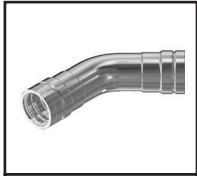

45° Elbow
DP40M017
Page G4



Tee
DP40M400
Page G4



End Cap
DP40M085
Page G5



**Flange - ANSI
#150**
DP40M018
Page G5

DP 40M Series - Metric Low Pressure

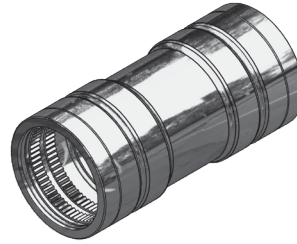
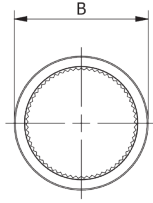
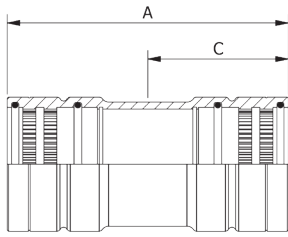

*MATERIAL CODE:
B = COPPER NICKEL 70/30

ORDER EXAMPLE:
DP40M100B44

Coupling, Metric - DP40M100

Size OD (mm)	Part Number	Dimensions - mm (Inch)			*Weight B kg (lbs)
		A	B	C Insertion Depth	
44.5	DP40M100B44	115.01 (4.53)	54.89 (2.16)	57.50 (2.26)	0.59 (1.31)
57	DP40M100B57	125.00 (4.92)	66.80 (2.63)	62.48 (2.46)	0.69 (1.52)

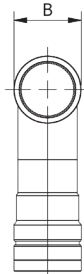
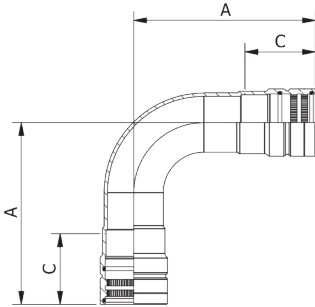

*MATERIAL CODE:
B = COPPER NICKEL 70/30

ORDER EXAMPLE:
DP40M300B44

90° Elbow, Metric - DP40M300

Size OD (mm)	Part Number	Dimensions - mm (Inch)			*Weight B kg (lbs)
		A	B	C Insertion Depth	
44.5	DP40M300B44	148.11 (5.83)	54.89 (2.16)	57.50 (2.26)	1.02 (2.24)
57	DP40M300B57	177.04 (6.97)	66.80 (2.63)	62.48 (2.46)	1.92 (4.23)

PYPLOK® DP 40 Series shapes such as Tees, Elbows and ANSI Flanged Ends are made as welded assemblies using ASME B16.9 CL200 Butt Weld Fittings.

DP 40M Series - Metric Low Pressure

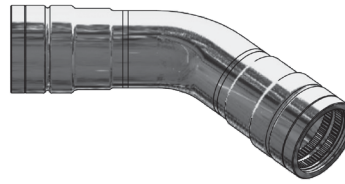
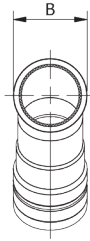
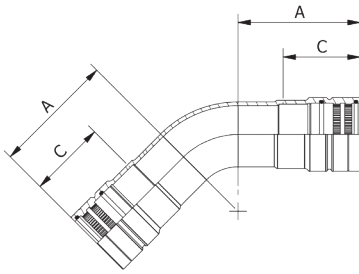

*MATERIAL CODE:
B = COPPER NICKEL 70/30

ORDER EXAMPLE:
DP40M017B44

45° Elbow, Metric - DP40M017

Size OD (mm)	Part Number	Dimensions - mm (Inch)			*Weight B kg (lbs)
		A	B	C Insertion Depth	
44.5	DP40M017B44	113.54 (4.47)	54.89 (2.16)	57.50 (2.26)	0.91 (2.01)
57	DP40M017B57	177.04 (6.97)	66.80 (2.63)	62.48 (2.46)	1.54 (3.40)

PYPLOK® DP 40 Series shapes such Tees, Elbows and ANSI Flanged Ends are made as welded assemblies using ASME B16.9 CL200 Butt Weld Fittings.

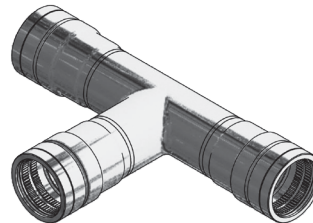
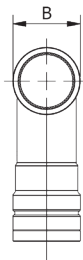
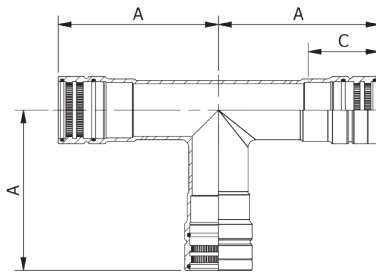

*MATERIAL CODE:
B = COPPER NICKEL 70/30

ORDER EXAMPLE:
DP40M400B44

Tee, Metric - DP40M400

Size OD (mm)	Part Number	Dimensions - mm (Inch)			*Weight B kg (lbs)
		A	B	C Insertion Depth	
44.5	DP40M400B44	130.56 (5.14)	54.89 (2.16)	57.50 (2.26)	1.39 (3.07)
57	DP40M400B57	146.05 (5.75)	66.80 (2.63)	62.48 (2.46)	2.39 (5.27)

PYPLOK® DP 40 Series shapes such Tees, Elbows and ANSI Flanged Ends are made as welded assemblies using ASME B16.9 CL200 Butt Weld Fittings.

DP 40M Series - Metric Low Pressure

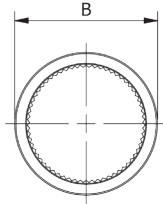
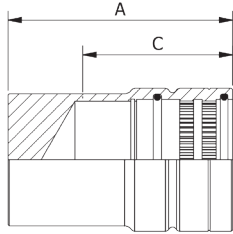

*MATERIAL CODE:
B = COPPER NICKEL 70/30

ORDER EXAMPLE:
DP40M085B44

End Cap, Metric - DP40M085

Size OD (mm)	Part Number	Dimensions - mm (Inch)			*Weight B kg (lbs)
		A	B	C Insertion Depth	
44.5	DP40M085B44	86.36 (3.40)	54.89 (2.16)	57.50 (2.26)	0.70 (1.55)
57	DP40M085B57	89.66 (3.53)	66.80 (2.63)	62.48 (2.46)	0.98 (2.16)

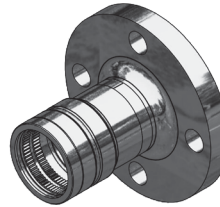
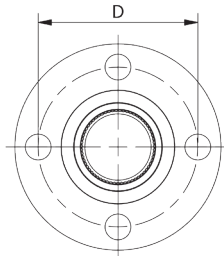
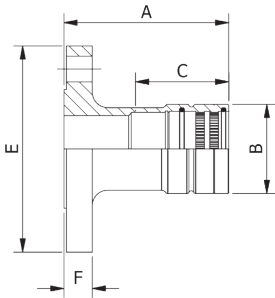

*MATERIAL CODE:
B = COPPER NICKEL 70/30

ORDER EXAMPLE:
DP40M118B44

Flange - ANSI #150, Metric - DP40M018

Size OD (mm)	Flange Size	Part Number	Dimensions - mm (Inch)						*Weight B kg (lbs)
			A	B	C Insertion Depth	D	E	F	
44.5	1-1/2"	DP40M018B4424	104.78 (4.13)	54.89 (2.16)	57.50 (2.26)	98.55 (3.88)	127.00 (5.00)	17.53 (0.69)	1.98 (4.37)
57	2"	DP40M018B5732	114.30 (4.50)	66.80 (2.63)	62.48 (2.46)	120.65 (4.75)	152.40 (6.00)	19.05 (0.75)	3.01 (6.63)

PYPLOK® DP 40 Series shapes such as Tees, Elbows and ANSI Flanged Ends are made as welded assemblies using ASME B16.9 CL200 Butt Weld Fittings.

PYPLOK® Tooling

The PYPLOK® Tooling System Consists of the Following Items

- Tube-Mac® Swage Tooling
- 10,000 PSI/690 bar Hydraulic Power Supply
- Inspection/Marking Gauges

Swage Tooling

The tools are lightweight, portable and activated by 10,000 PSI/690 bar hydraulic pressure. The swage tools are identical in design. The only difference is the force generated by each model.

The following models are used to install the PYPLOK® fittings:

DLT10 – 1/4" OD and 6mm-8mm

DLT20 – 1/4"-3/8" NPS, 1/4"-5/8" OD and 6mm-16mm

DLT40 – 1/4"-3/4" NPS, 3/8"-1" OD and 8mm-30mm

DLT55 – 1/2"-1-1/2" NPS, 1"-2" OD and 22mm-57mm

DLT70 – 1"-3" NPS, 1-1/2"-2" OD and 35mm-76mm

DLT86 – 3"-4" NPS

Swage Tooling Primary Components

The PYPLOK® swage tooling assembly has four main components:

- Power Unit
- Head Assembly
- Swage Dies
- Die Block Assembly

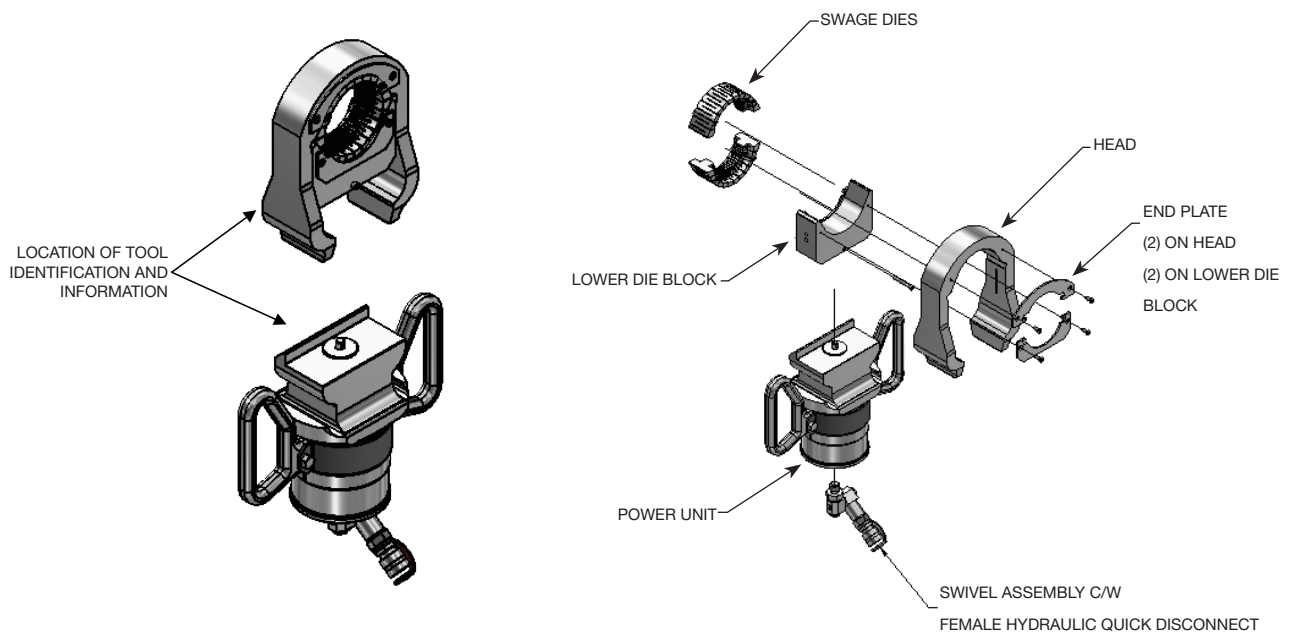

PYPLOK® Tooling Dimensions

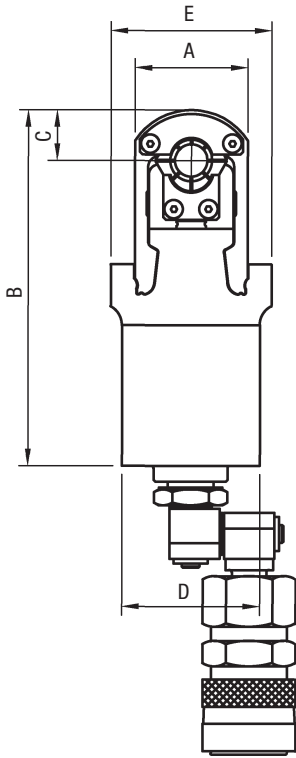

Model 10

Head Size	Dimensions - Inch (mm)				
	A	B	C	D	E
01' Series	1.33 (33.86)	4.22 (107.21)	0.60 (15.24)	1.63 (41.40)	1.90 (48.26)

Head Size	Weight - lbs (kg)		
	Power Unit	Head Assembly	Complete Tool
01' Series	2.00 (0.90)	0.03 (0.20)	2.40 (1.10)

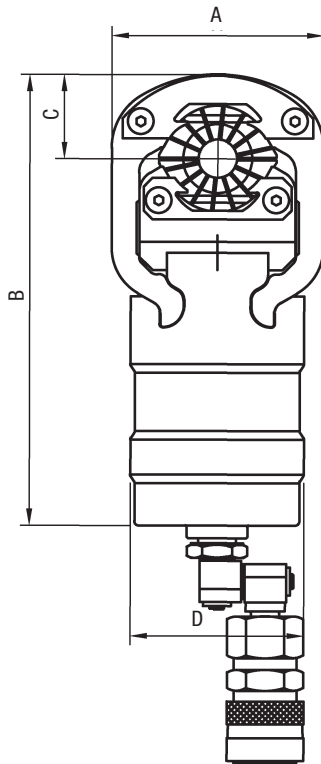

Model 20

Head Size	Dimensions - Inch (mm)			
	A	B	C	D
00' Series	3.04 (77.22)	6.48 (164.67)	1.21 (30.84)	2.49 (63.25)

Head Size	Weight - lbs (kg)		
	Power Unit	Head Assembly	Complete Tool
00' Series	4.40 (2.00)	3.10 (1.40)	7.50 (3.40)

PYPLOK® Tooling Dimensions

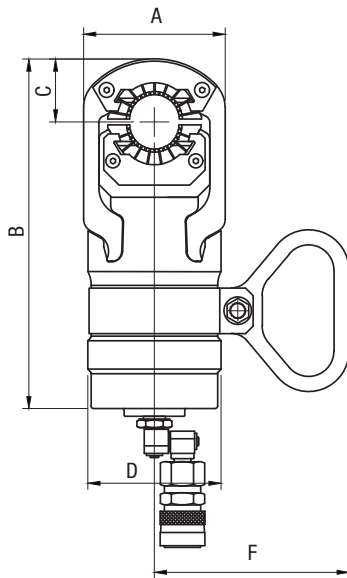

*Model 40

Head Size	Dimensions - Inch (mm)				
	A	B	C	D	F
00' Series	3.29 (83.57)	8.23 (209.12)	1.15 (29.26)	3.29 (83.59)	4.81 (122.23)
02' Series	3.50 (88.88)	8.63 (219.28)	1.55 (39.45)	3.29 (83.59)	4.81 (122.23)

Head Size	Weight - lbs (kg)		
	Power Unit	Head Assembly	Complete Tool
00' Series	9.20 (4.20)	4.20 (1.90)	13.40 (6.10)
02' Series	9.20 (4.20)	5.30 (2.40)	14.60 (6.60)

*Handle is an option. Not standard with model 40.

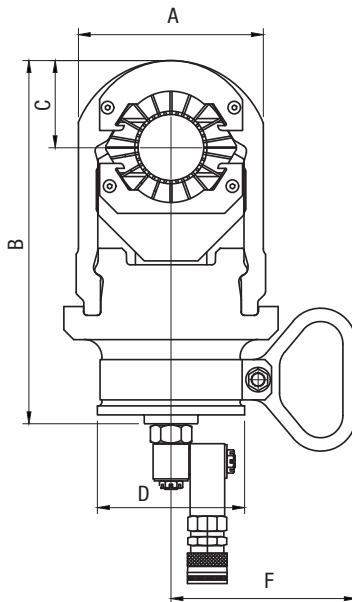

*Model 55

Head Size	Dimensions - Inch (mm)				
	A	B	C	D	F
01' Series	5.18 (131.57)	9.92 (251.92)	2.43 (61.70)	4.12 (104.65)	5.19 (131.78)

Head Size	Weight - lbs (kg)		
	Power Unit	Head Assembly	Complete Tool
01' Series	16.70 (7.60)	11.20 (5.10)	27.90 (12.70)

*Handle is an option. Not standard with model 55.

PYPLOK® Tooling Dimensions

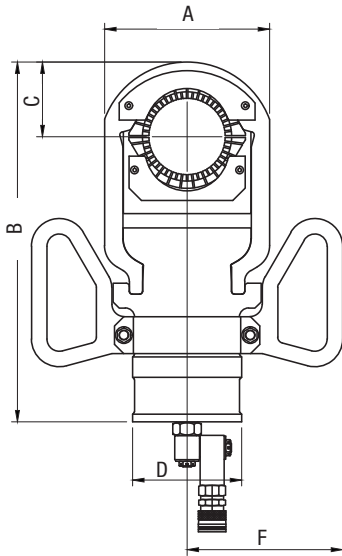

*Model 70

Head Size	Dimensions - Inch (mm)				
	A	B	C	D	F
01' Series	6.68 (169.70)	14.62 (371.45)	3.03 (76.99)	4.41 (112.07)	6.30 (159.97)
02' Series	7.55 (191.77)	15.23 (386.77)	3.62 (92.05)	4.41 (112.07)	6.30 (159.97)

Head Size	Weight - lbs (kg)		
	Power Unit	Head Assembly	Complete Tool
01' Series	30.80 (14.00)	17.60 (8.00)	48.40 (22.00)
02' Series	30.80 (14.00)	23.10 (10.50)	53.90 (24.50)

*Handle comes standard with model 70.

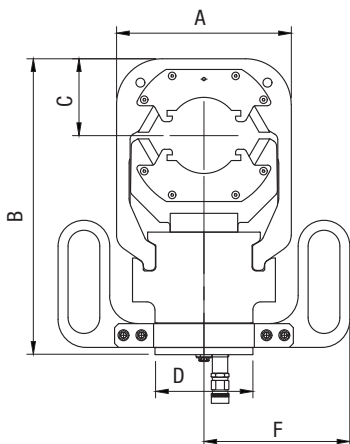

*Model 86

Head Size	Dimensions - Inch (mm)				
	A	B	C	D	F
00' Series	11.00 (279.40)	19.50 (495.30)	5.00 (127.00)	6.25 (158.75)	18.00 (457.20)

Head Size	Weight - lbs (kg)		
	Power Unit	Head Assembly	Complete Tool
00' Series	61.70 (28.00)	62.20 (28.20)	123.90 (56.20)

*Handle comes standard with model 86.

PYPLOK® Tooling Size Range Coverage

DM 20 Series - NPS Pipe									
	1/4"	3/8"	1/2"	3/4"	1"	1-1/4"	1-1/2"	2"	3"
Model 20									
Model 40									
Model 55									
Model 70									
Model 86									

DM 60 Series - OD Tube									
	1/4"	3/8"	1/2"	5/8"	3/4"	1"	1-1/4"	1-1/2"	2"
Model 10									
Model 20									
Model 40									
Model 55									
Model 70									

DM 80 Series - Metric Tube																	
	6mm	8mm	10mm	12mm	15mm	16mm	18mm	20mm	22mm	25mm	28mm	30mm	35mm	38mm	42mm	50mm	60mm
Model 10																	
Model 20																	
Model 40																	
Model 55																	
Model 70																	

DP 40N Series - NPS Low Pressure			
	2-1/2"	3"	4"
Model 70			
Model 86			

DP 40M Series - Metric Low Pressure		
	44.5mm	57mm
Model 55		

Introduction

Technical Information

DM 20 – NPS Pipe

DM 60 – OD Tube

DM 80 – Metric & JIS Tube

DP 40N – NPS Low Pressure

DP 40M – Metric Low Pressure

PYPLOK® Tooling

Installation Procedures

Appendix

PYPLOK® Tool Matrix

DM 20 Series - NPS Pipe

Model 40 Power Unit - DLT40MAPW0000

Size	Fitting Series	Inspection Gauge	Die Set	Die Block	Head	Upper Endplates	Lower Endplates	Endplate Bolts	*Head Assembly
Model 40-00' Series									MS51595-61 10-24 x 3/8" Flat Socket Cap
1/4"	DM 20 Series	DLT40PYIG3804	DLT40PYDI3804	DLT40MADA0000	DLT40MAHD0000	DLT40PYEU0000	DLT40PYEL0000	DLT40PYHA3804	
3/8"		DLT40PYIG3806	DLT40PYDI3806					DLT40PYHA3806	
Model 40 - 02' Series									
1/2"	DM 20 Series	DLT40PYIG3808	DLT40PYDI3808	DLT40MADA0002	DLT40MAHD0002	DLT40PYEU0002	DLT40PYEL0002	DLT40PYHA3808	
3/4"		DLT40PYIG3812	DLT40PYDI3812					DLT40PYHA3812	

Model 55 Power Unit - DLT55MAPW0000

Size	Fitting Series	Inspection Gauge	Die Set	Die Block	Head	Upper Endplates	Lower Endplates	Endplate Bolts	*Head Assembly
Model 55 - 01' Series									MS51595-61 10-24 x 3/8" Flat Socket Cap
1/2"	DM 20 Series	DLT40PYIG3808	DLT55PYDI3808	DLT55MADA0001	DLT55MAHD0001	DLT55PYEU0001	DLT55PYEL0001	DLT55PYHA3808	
3/4"		DLT40PYIG3812	DLT55PYDI3812					DLT55PYHA3812	
1"		DLT55PYIG3816	DLT55PYDI3816					DLT55PYHA3816	
1-1/4"		DLT55PYIG3820	DLT55PYDI3820					DLT55PYHA3820	
1-1/2"		DLT55PYIG3824	DLT55PYDI3824					DLT55PYHA3824	

Model 70 Power Unit - DLT70MAPW0000

Size	Fitting Series	Inspection Gauge	Die Set	Die Block	Head	Upper Endplates	Lower Endplates	Endplate Bolts	*Head Assembly
Model 70 - 01' Series									MS51595-61 10-24 x 3/8" Flat Socket Cap
1"	DM 20 Series	DLT55PYIG3816	DLT70PYDI3816	DLT70MADA0001	DLT70MAHD0001	DLT70PYEU0001	DLT70PYEL0001	DLT70PYHA3816	
1-1/4"		DLT55PYIG3820	DLT70PYDI3820					DLT70PYHA3820	
1-1/2"		DLT55PYIG3824	DLT70PYDI3824					DLT70PYHA3824	
2"		DLT70PYIG3832	DLT70PYDI3832					DLT70PYHA3832	

Model 86 Power Unit - DLT86MAPW0000

Size	Fitting Series	Inspection Gauge	Die Set	Die Block	Head	Upper Endplates	Lower Endplates	Endplate Bolts	*Head Assembly
Model 86 - 00' Series									1/4-28 x 1/2" Socket Cap
3"	DM 20 Series	DLT86PYIG3848	DLT86PYDI3848	DLT86MADA0000	DLT86MAHD0000	DLT86PYEU0001	DLT86PYEL0001	DLT86PYHA3848	

*Head Assembly Includes: Die Set, Die Block, Head, Endplates and Endplate Bolts

PYPLOK® Tool Matrix

DM 60 Series - OD Tube

Model 10 Power Unit - DLT10MAPW0000

Size	Fitting Series	Inspection Gauge	Die Set	Die Block	Head	Upper Inboard	Upper Outboard	Lower Inboard	Lower Outboard	*Head Assembly
Model 10 - 01' Series										
1/4"	DM 60 Series	DLT10PYIG3704	DLT10PYDI3704	DLT10MADA0001	DLT10MAHD0001	DLT10PSEU4006	DLT10PYFU704	DLT10PSEL4006	DLT10PSFL4006	DLT10PYHA3704

Model 20 Power Unit - DLT20MAPW0000

Size	Fitting Series	Inspection Gauge	Die Set	Die Block	Head	Upper Endplates	Lower Endplates	Endplate Bolts	*Head Assembly
Model 20 - 00' Series									
3/8"	DM 60 Series	DLT40PYIG3706	DLT20PYDI3706	DLT20MADA0001	DLT20MADA0000	DLT40PYEU0000	DLT40PYEL0000	MS51595-61 10-24 x 3/8" Flat Socket Cap	DLT20PYHA3706
1/2"		DLT40PYIG3708	DLT20PYDI3708						DLT20PYHA3708
5/8"		DLT40PYIG3710	DLT20PYDI3916						DLT20PYHA3916

Model 40 Power Unit - DLT40MAPW0000

Size	Fitting Series	Inspection Gauge	Die Set	Die Block	Head	Upper Endplates	Lower Endplates	Endplate Bolts	*Head Assembly
Model 40 - 00' Series									
3/8"	DM 60 Series	DLT40PYIG3706	DLT40PYDI3706	DLT40MADA0000	DLT40MAHD0000	DLT40PYEU0000	DLT40PYEL0000	MS51595-61 10-24 x 3/8" Flat Socket Cap	DLT40PYHA3706
1/2"		DLT40PYIG3708	DLT40PYDI3708						DLT40PYHA3708
5/8"		DLT40PYIG3710	DLT40PYDI3916						DLT40PYHA3916
Model 40 - 02' Series									
3/4"	DM 60 Series	DLT40PYIG3712	DLT40PYDI3712	DLT40MADA0002	DLT40MAHD0002	DLT40PYEU0002	DLT40PYEL0002		DLT40PYHA3712
1"		DLT40PYIG3716	DLT40PYDI3716						DLT40PYHA3716

Model 55 Power Unit - DLT55MAPW0000

Size	Fitting Series	Inspection Gauge	Die Set	Die Block	Head	Upper Endplates	Lower Endplates	Endplate Bolts	*Head Assembly
Model 55 - 01' Series									
1"	DM 60 Series	DLT40PYIG3716	DLT55PYDI3716	DLT55MADA0001	DLT55MAHD0001	DLT55PYEU0001	DLT55PYEL0001	MS51595-61 10-24 x 3/8" Flat Socket Cap	DLT55PYHA3716
1-1/4"		DLT55PYIG3720	DLT55PYDI3720						DLT55PYHA3720
1-1/2"		DLT55PYIG3938	DLT55PYDI3938						DLT55PYHA3938
2"		DLT55PYIG3732	DLT55PYDI3824						DLT55PYHA3824

*Head Assembly Includes: Die Set, Die Block, Head, Endplates and Endplate Bolts

PYPLOK® Tool Matrix

DM 80 Series - Metric Tube

Model 10 Power Unit - DLT10MAPW0000										
Size	Fitting Series	Inspection Gauge	Die Set	Die Block	Head	Upper Inboard	Upper Outboard	Lower Inboard	Lower Outboard	*Head Assembly
Model 10 - 01' Series										
6mm	DM 80 Series	DLT10PYIG3906	DLT10PYDI3704	DLT10MADA0001	DLT10MAHD0001	DLT10PSEU4006	DLT10PYFU704	DLT10PSEL4006	DLT10PSFL4006	DLT10PYHA3704
8mm		DLT10PYIG3908	DLT10PYDI3908							DLT10PYHA3908

Model 20 Power Unit - DLT20MAPW0000										
Size	Fitting Series	Inspection Gauge	Die Set	Die Block	Head	Upper Endplates	Lower Endplates	Endplate Bolts	*Head Assembly	
Model 20 - 00' Series										
8mm	DM 80 Series	DLT40PYIG3908	DLT20PYDI3908	DLT20MADA0000	DLT20MAHD0000	DLT40PYEU0000	DLT40PYEL0000	MS51595-61 10-24 x 3/8" Flat Socket Cap	DLT20PYHA3908	
10mm		DLT40PYIG3910	DLT20PYDI3910						DLT20PYHA3910	
12mm		DLT40PYIG3912	DLT20PYDI3912						DLT20PYHA3912	
15mm		DLT40PYIG3915	DLT20PYDI3916						DLT20PYHA3916	
16mm		DLT40PYIG3916	DLT20PYDI3916						DLT20PYHA3916	

Model 40 Power Unit - DLT40MAPW0000										
Size	Fitting Series	Inspection Gauge	Die Set	Die Block	Head	Upper Endplates	Lower Endplates	Endplate Bolts	*Head Assembly	
Model 40 - 00' Series										
8mm	DM 80 Series	DLT40PYIG3908	DLT20PYDI3908	DLT40MADA0000	DLT40MAHD0000	DLT40PYEU0000	DLT40PYEL0000	MS51595-61 10-24 x 3/8" Flat Socket Cap	DLT40PYHA3908	
10mm		DLT40PYIG3910	DLT40PYDI3910						DLT40PYHA3910	
12mm		DLT40PYIG3912	DLT40PYDI3912						DLT40PYHA3912	
14mm		DLT40PYIG3914	DLT40PYDI3804						DLT40PYHA3804	
15mm		DLT40PYIG3915	DLT40PYDI3916						DLT40PYHA3916	
16mm		DLT40PYIG3916	DLT40PYDI3916						DLT40PYHA3916	
18mm		DLT40PYIG3918	DLT40PYDI3806						DLT40PYHA3806	
20mm		DLT40PYIG3920	DLT40PYDI3920						DLT40PYHA3920	
Model 40 - 02' Series										
22mm	DM 80 Series	DLT40PYIG3922	DLT40PYDI3808	DLT40MADA0002	DLT40MAHD0002	DLT40PYEU0002	DLT40PYEL0002	MS51595-61 10-24 x 3/8" Flat Socket Cap	DLT40PYHA3808	
25mm		DLT40PYIG3925	DLT40PYDI3925						DLT40PYHA3925	
28mm		DLT40PYIG3928	DLT40PYDI3812						DLT40PYHA3812	
30mm		DLT40PYIG3930	DLT40PYDI3930						DLT40PYHA3930	

*Head Assembly Includes: Die Set, Die Block, Head, Endplates and Endplate Bolts

PYPLOK® Tool Matrix

DM 80 Series - Metric Tube

Model 55 Power Unit - DLT55MAPW0000

Size	Fitting Series	Inspection Gauge	Die Set	Die Block	Head	Upper Endplates	Lower Endplates	Endplate Bolts	*Head Assembly
Model 55 - 01' Series									
22mm	DM 80 Series	DLT40PYIG3922	DLT55PYDI3808	DLT55MADA0001	DLT55MAHD0001	DLT55PYEU0001	DLT55PYEU0001	MS51595-61 10-24 x 3/8" Flat Socket Cap	DLT55PYHA3808
25mm		DLT40PYIG3925	DLT55PYDI3925						DLT55PYHA3925
28mm		DLT40PYIG3928	DLT55PYDI3812						DLT55PYHA3812
30mm		DLT40PYIG3930	DLT55PYDI3930						DLT55PYHA3930
35mm		DLT55PYIG3935	DLT55PYDI3816						DLT55PYHA3816
38mm		DLT55PYIG3938	DLT55PYDI3938						DLT55PYHA3938
42mm		DLT55PYIG3820	DLT55PYDI3820						DLT55PYHA3820
50mm		DLT55PYIG3950	DLT55PYDI3824						DLT55PYHA3824

Model 70 Power Unit - DLT70MAPW0000

Size	Fitting Series	Inspection Gauge	Die Set	Die Block	Head	Upper Endplates	Lower Endplates	Endplate Bolts	*Head Assembly
Model 70 - 01' Series									
35mm	DM 80 Series	DLT55PYIG3935	DLT70PYDI3816	DLT70MADA0001	DLT70MAHD0001	DLT70PYEU0001	DLT70PYEL0001	MS51595-61 10-24 x 3/8" Flat Socket Cap	DLT70PYHA3816
38mm		DLT55PYIG3938	DLT70PYDI3938						DLT70PYHA3938
42mm		DLT55PYIG3820	DLT70PYDI3820						DLT70PYHA3820
50mm		DLT55PYIG3950	DLT70PYDI3824						DLT70PYHA3824
60mm		DLT70PYIG3832	DLT70PYDI3832						DLT70PYHA3832

*Head Assembly Includes: Die Set, Die Block, Head, Endplates and Endplate Bolts

Introduction

Technical Information

DM 20 – NPS Pipe

DM 60 – OD Tube

DM 80 – Metric & JIS Tube

DP 40N – NPS Low Pressure

DP 40M – Metric Low Pressure

PYPLOK® Tooling

Installation Procedures

Appendix

PYPLOK® Tool Matrix

DM 80 Series - JIS Metric Tube

Model 40 Power Unit - DLT40MAPW0000

Size	Fitting Series	Inspection Gauge	Die Set	Die Block	Head	Upper Endplates	Lower Endplates	Endplate Bolts	*Head Assembly
Model 40-00' Series									MS51595-61 10-24 x 3/8" Flat Socket Cap
1/4"	08A	DLT40PYIG3908A	DLT40PYDI3804	DLT40MADA0000	DLT40MAHD0000	DLT40PYEU0000	DLT40PYEL0000	DLT40PYHA3804	
3/8"	10A	DLT40PYIG3910A	DLT40PYDI3806					DLT40PYHA3806	
Model 40 - 02' Series									
1/2"	15A	DLT40PYIG3915A	DLT40PYDI3808	DLT40MADA0002	DLT40MAHD0002	DLT40PYEU0002	DLT40PYEL0002	DLT40PYHA3808	
3/4"	20A	DLT40PYIG3920A	DLT40PYDI3812					DLT40PYHA3812	

Model 55 Power Unit - DLT55MAPW0000

Size	Fitting Series	Inspection Gauge	Die Set	Die Block	Head	Upper Endplates	Lower Endplates	Endplate Bolts	*Head Assembly
Model 55 - 01' Series									MS51595-61 10-24 x 3/8" Flat Socket Cap
1/2"	15A	DLT40PYIG3915A	DLT55PYDI3808	DLT55MADA0001	DLT55MAHD0001	DLT55PYEU0001	DLT55PYEL0001	DLT55PYHA3808	
3/4"	20A	DLT40PYIG3920A	DLT55PYDI3812					DLT55PYHA3812	
1"	25A	DLT55PYIG3925A	DLT55PYDI3816					DLT55PYHA3816	
1-1/4"	32A	DLT55PYIG3932A	DLT55PYDI3820					DLT55PYHA3820	
1-1/2"	40A	DLT55PYIG3940A	DLT55PYDI3824					DLT55PYHA3824	

Model 70 Power Unit - DLT70MAPW0000

Size	Fitting Series	Inspection Gauge	Die Set	Die Block	Head	Upper Endplates	Lower Endplates	Endplate Bolts	*Head Assembly
Model 70 - 01' Series									MS51595-61 10-24 x 3/8" Flat Socket Cap
1"	25A	DLT55PYIG3925A	DLT70PYDI3816	DLT70MADA0001	DLT70MAHD0001	DLT70PYEU0001	DLT70PYEL0001	DLT70PYHA3816	
1-1/4"	32A	DLT55PYIG3932A	DLT70PYDI3820					DLT70PYHA3820	
1-1/2"	40A	DLT55PYIG3940A	DLT70PYDI3824					DLT70PYHA3824	
2"	50A	DLT70PYIG3950A	DLT70PYDI3832					DLT70PYHA3832	

*Head Assembly Includes: Die Set, Die Block, Head, Endplates and Endplate Bolts

PYPLOK® Tool Matrix

DP 40N Series - NPS Low Pressure

Model 70 Power Unit - DLT70MAPW0000									
Size	Fitting Series	Inspection Gauge	Die Set	Die Block	Head	Upper Endplates	Lower Endplates	Endplate Bolts	*Head Assembly
Model 70 - 02' Series									
2-1/2"	DP 40N Series	DLT70PYIG4040	DLT70PYDI4040	DLT70MADA0002	DLT70MAHD0002	DLT70PYEU0002	DLT70PYEL0002	MS51595-61 10-24 x 3/8" Flat Socket Cap	DLT70PYHA4040
3"		DLT70PYIG4048	DLT70PYDI4048						DLT70PYHA4048

Model 86 Power Unit - DLT86MAPW0000									
Size	Fitting Series	Inspection Gauge	Die Set	Die Block	Head	Upper Endplates	Lower Endplates	Endplate Bolts	*Head Assembly
Model 86 - 00' Series									
4"	DP 40N Series	DLT86PYIG4064	DLT86PYDI4064	DLT86MADA0000	DLT86MAHD0000	DLT86PYEP0001	DLT86PYEP0001	1/4-28 x 1/2" Socket Cap	DLT86PYHA4064

*Head Assembly Includes: Die Set, Die Block, Head, Endplates and Endplate Bolts

DP 40M Series - Metric Low Pressure

Model 55 Power Unit - DLT55MAPW0000									
Size	Fitting Series	Inspection Gauge	Die Set	Die Block	Head	Upper Endplates	Lower Endplates	Endplate Bolts	*Head Assembly
Model 55 - 01' Series									
44.5mm	DP 40M Series	DLT55PYIG4244	DLT55PYDI3944	DLT55MADA0001	DLT55MAHD0001	DLT55PYEU0001	DLT55PYEL0001	MS51595-61 10-24 x 3/8" Flat Socket Cap	DLT55PYHA3944
57mm		DLT55PYIG4257	DLT55PYDI3957						DLT55PYHA3957

*Head Assembly Includes: Die Set, Die Block, Head, Endplates and Endplate Bolts

PYPLOK® Tooling

PYPLOK® Tooling CE Compliance

The PYPLOK® swage tooling assembly has four main components:

- Power Unit
- Head Assembly
- Swage Dies
- Die Block Assembly

PYPLOK® Swaging Tool Pump Requirements

1. Depending on application and environment the choice of Electric, Battery, Pneumatic or Hand Operated pumps can be used.
2. The hydraulic pumps used for operation of the PYPLOK® Tooling must be capable of producing up to but not exceeding 10,000 PSI/690 bar and have internal relief valve to prevent pump from producing more than 10,000 PSI/690 bar within the PYPLOK® Tools.
3. Power operated pumps must operate in hold-to-run mode (hydraulic supply only as long as push-button or pedal is activated, hydraulic Stop or Release when push-button or pedal are released). PYPLOK® has defined PL = c (EN ISO 13849) as requirement for the control circuit.
4. The hydraulic hose and quick connectors joining the pump to the PYPLOK® Tooling must be rated for use with a 10,000 PSI/690 bar Pump.

Pumps Offered by Tube-Mac® for Use with the PYPLOK® Tooling

Part Number	Description	Weight lbs (kg)
P392	Hand Pump	9.00 (4.10)
XA11G	Pneumatic Pump	19.40 (8.80)
PUD1100EU102	220 Volt Electric Pump	31.00 (14.05)
PUD1100BU112	110 Volt Electric Pump	31.00 (14.05)
B68M-P18	Battery Pump, 110V Charger	20.28 (9.20)
B68M-P18-220	Battery Pump, 220V Charger	20.28 (9.20)

Pumps come complete with carrying case and a 10 ft., 10,000 PSI/690 bar, non-conductive hose

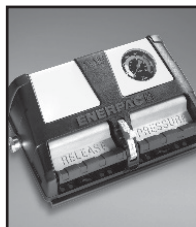

PYPLOK® Tooling Accessories

PYPLOK® Tooling Accessories

DLT10PYCC1200	Case for (1) Model 10 Power Unit and (2) Head Assemblies
DLT20PYCC1200	Case for (1) Model 20 Power Unit and (2) Head Assemblies
DLT40PYCC1501	Case for (1) Model 40 Power Unit and (6) Head Assemblies
DLT55PYCC1501	Case for (1) Model 55 Power Unit and (1) Head Assembly
DLT55PYCC1502	Case for (2) Model 55 Head Assemblies
DLT70PYCC1501	Case for (1) Model 70 Power Unit
DLT70PYCC1502	Case for (2) Model 70 Head Assemblies
DLT70PYCC1503	Case for (1) Model 70 3" Head Assembly
DLT86PYCC0001	Case for (1) Model 86 Power Unit
DLT86PYCC0002	Case for (1) Model 86 Head Assembly
DLTXXPYSL0000	Swage Lube
DLT00HOSE0010	10' Hose Assembly comes with Quick Disconnects
DLT00HOSE0015	15' Hose Assembly comes with Quick Disconnects
DLT00SABP1040	Quick Disconnect Swivel Assembly for Model 10/20/40
DLT00SABP5570	Quick Disconnect Swivel Assembly for Model 55/70

Spare Endplates and Bolts

DLT10PYFU3704	Model 10 - Upper Out Endplate
DLT10PSEU4006	Model 10 - Upper In Endplate
DLT10PSFL4006	Model 10 - Lower Out Endplate
DLT10PSEL4006	Model 10 - Lower In Endplate
DLT20PYEU0000	Model 20 - Upper Endplate
DLT20PYEL0000	Model 20 - Lower Endplate
DLT40PYEU0000	Model 40 - 00' Series Upper Endplate
DLT40PYEL0000	Model 40 - 00' Series Lower Endplate
DLT40PYEU0002	Model 40 - 02' Series Upper Endplate
DLT40PYEL0002	Model 40 - 02' Series Lower Endplate
DLT55PYEU0001	Model 55 - Upper Endplate
DLT55PYEL0001	Model 55 - Lower Endplate
DLT70PYEU0001	Model 70 - 01' Series Upper Endplate
DLT70PYEL0001	Model 70 - 01' Series Lower Endplate
DLT70PYEU0002	Model 70 - 02' Series Upper Endplate
DLT70PYEL0002	Model 70 - 02' Series Lower Endplate
DLT86PYEP0001	Model 86 - Upper/Lower Endplate
10-24 x 3/8"	Flat Socket Cap Bolts for Model 20/40/55/70 Endplates
1/4-28 x 1/2"	Socket Cap Bolts for Model 86 Endplates

Optional Safety Endplates and Handles

DLT40PSPA000	Model 40 - 00' Series Upper Safety Endplate Kit
DLT40PSPA0002	Model 40 - 02' Series Upper Safety Endplate Kit
DLT55PSPA0001	Model 55 - Series Upper Safety Endplate Kit
DLT70PSPA0001	Model 70 - 01' Series Upper Safety Endplate Kit
DLT70PSPA0002	Model 70 - 02' Series Upper Safety Endplate Kit
DLT00PHLA4055	Model 40/55 Handle Kit
DLT70PHLA0000	Model 70 Handle Kit
DLT40PHLA0000	Model 40 Handle Kit
DLT55PHLA0000	Model 55 Handle Kit
DLT70PHLA0000	Model 70 Handle Kit

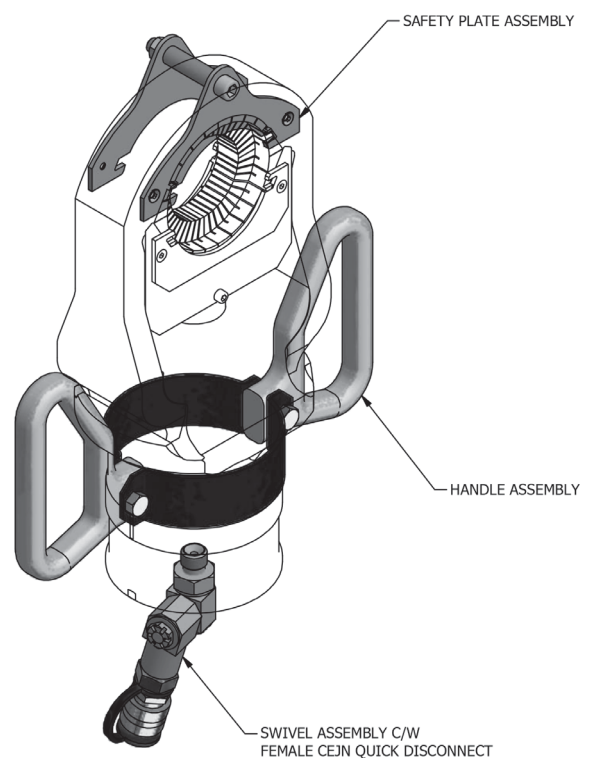

Introduction

Technical Information

DM 20 – NPS Pipe

DM 60 – OD Tube

DM 80 – Metric & JIS Tube

DP 40N – NPS Low Pressure

DP 40M – Metric Low Pressure

PYPLOK® Tooling

Installation Procedures

Appendix

Installation Procedures

PYPLOK® Swaging Tool Parts and Equipment

Please see PYPLOK® Installation Manual for more in-depth information on installation procedures.

WARNING

TOOL TO BE OPERATED BY QUALIFIED TRAINED PERSONNEL ONLY. REFER TO PYPLOK INSTALLATION MANUAL FOR PROPER OPERATING METHODS AND SAFE PRACTICES. DUE TO HIGH SWAGING FORCES, HEAD AND UPPER SECTION OF POWER UNIT MUST BE FULLY ENGAGED AND FLUSH ON BOTH SIDES. PARTIAL ENGAGEMENT MAY CAUSE TOOL FAILURE. SWIVEL AND QUICK CONNECT ASSEMBLY MUST BE INSTALLED PROPERLY BEFORE OPERATION OF PUMP. MAXIMUM ALLOWABLE OPERATING PRESSURE MUST NOT EXCEED 10,000 PSI / 690 BAR.

WARNING

1. The PYPLOK® Tooling is intended for installing PYPLOK® Fittings in a safe and efficient manner. The operation of the tooling by means of an external hydraulic supply to crimp the PYPLOK® Fitting into place on matching tube or piping systems for a permanent, leak free, non-welded connection.
2. Select appropriate swage die set, apply swage lube to the bottom surface of the dies and landing areas of Lower Die Block and Head then insert (1) half of die set into lower die block and (1) half of die set into head. Attach endplates with bolts ensuring the tabs of the swage dies are located in the open slots of the endplates. Note that MSDS information for swage lube is available upon request and prolonged skin contact should be avoided although it is non-hazardous.
3. Check to ensure that the swage dies are located properly within the endplates and can move freely when pushed down.
4. Follow the above process when changing swage die sets for other sizes.
5. Used dies are to be inspected for debris and cleaned if required. Clean with pressurized air, soft brush or hand cloth removing all old swage lube and debris within the die slots and other surfaces.

Introduction

Technical Information

DM 20 – NPS Pipe

DM 60 – OD Tube

DM 80 – Metric & JIS Tube

DP 40N – NPS Low Pressure

DP 40M – Metric Low Pressure

PYPLOK® Tooling

Installation Procedures

Appendix

Installation Procedures

Pipe Preparation

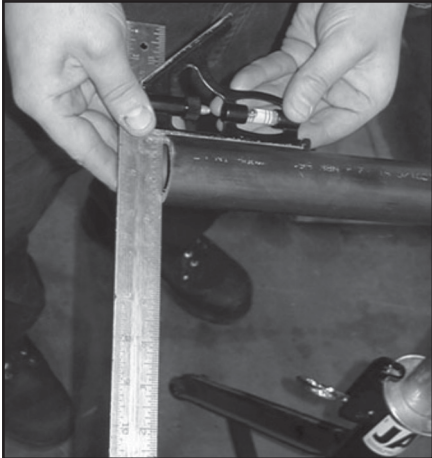

- Cut the pipe to desired length.
- Ensure that cut is square but up to 5° off square is acceptable.



- The pipe must be free of any scale, rust, paint, lacquer and any major scratches, gouges or weld seams.
- Use aluminum oxide cloth grit 80-400 or an abrasive wheel/tool to remove all debris from the pipe down to bare metal.
- It is important to note that all cleaning of the external pipe must only be done radially around the pipe and not longitudinally.
- Do not use a grinder or any other tool that will leave a rough, uneven or flat surface after cleaning.
- Do not use a wire wheel to attempt to remove lacquer.



- Deburr outside diameter of pipe with a file and the inside diameter with an internal deburring tool.
- It is critical to remove all sharp edges to prevent damage to the PYPLOK® fitting seals.

Installation Procedures

Pipe Preparation - Special Notice

Carbon Steel Pipe With Surface Treatment

Special attention must be taken when using Carbon pipe with surface applications including lacquer, paint, galvanizing and other treatments. All surface treatments must be completely removed as per Pipe Preparation methods listed so that the sealing surface of the pipe is bare metal. If the sealing area is not cleared down to bare, smooth metal proper sealing of the PYPLOK® Fitting will be limited. Examples of improper pipe surfaces are found below:

Surface Not Cleaned

Lacquer Not Removed From Pipe

Surface Properly Cleaned/ Bare Metal Surface

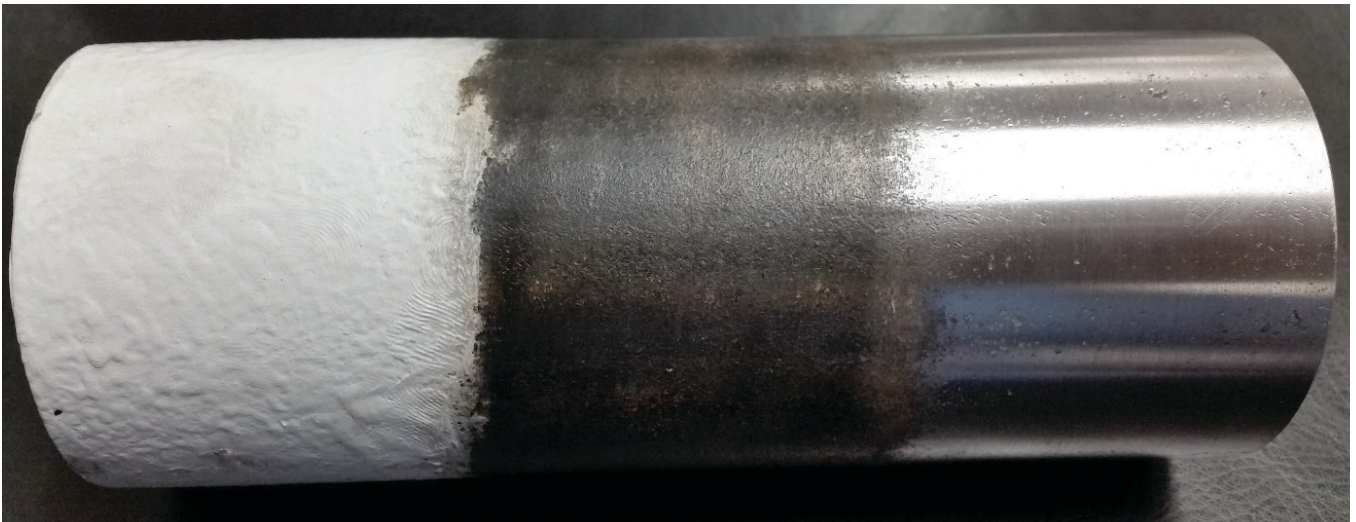

Gas Applications

Gases such as nitrogen are made of tiny molecules able to go through the smallest leak paths on pipe surfaces. Any foreign debris including surface treatments and or gouges/scratches can cause leaks. The most reliable connection is achieved when proper installation instructions are followed including very specific pipe surface preparation. Whenever possible, heavier pipe wall thickness should be used to offer a more reliable seal as the heavier wall will offer more resistance to the compressed fitting compared to thin wall. It may be required to pressure test a gas system to a much greater level than the operational pressure required. This will help set the pipe against the compressed fitting. Therefore, it is acceptable to pressure test the system to the maximum design pressure of the fittings or pipe (whichever is the lower value) in accordance with national and local regulations.

Installation Procedures

Verify Diameter of the Pipe Using the Inspection Gauge

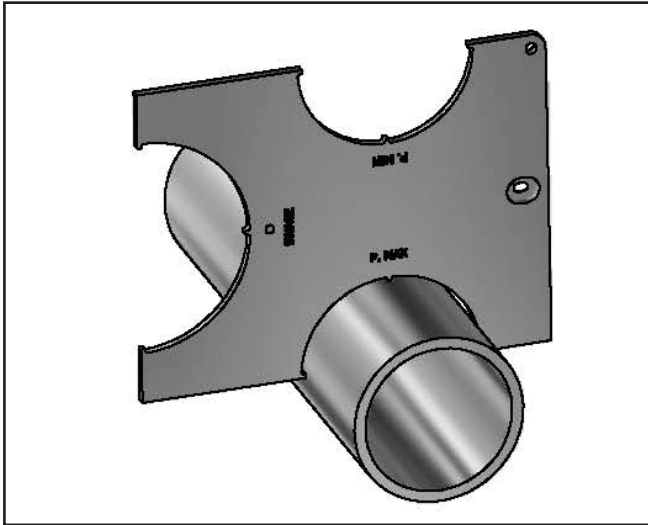

- P. Max gauge should fit 360° around the pipe. The area of the pipe to be inspected is the location where the fitting is intended to be installed.

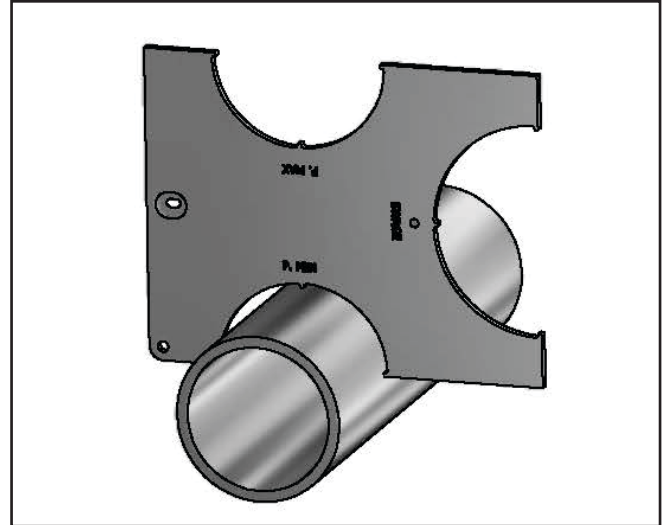

- P. Min gauge should not be able to fit at any point 360° around pipe. The area of the pipe to be inspected is the location where the fitting is intended to be installed.

Note: If these criteria are not met, then a new location on the existing line that is acceptable must be used or the pipe cannot be used and new material is required. Pipe that does not meet the required dimension may not properly operate after crimping.

Pipe Marking

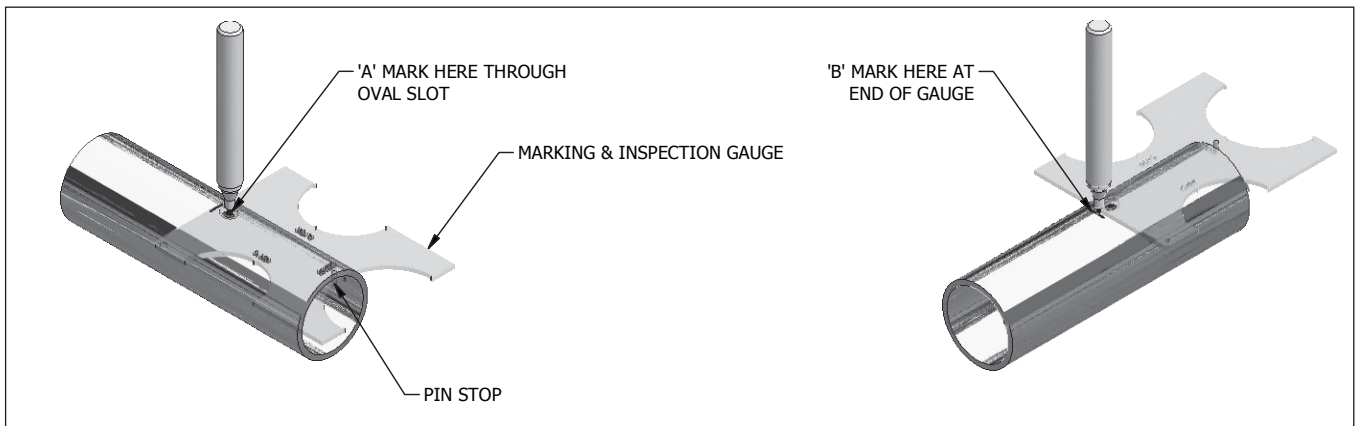

- Position the inspection gauge on the pipe with the pin stop pressed up against the pipe end as shown.
- Make the “A” oval mark on the pipe through the oval marking slot in gauge.
- Make the “B” line mark at the end of the gauge.

Note: The minimum space between two fittings is 2x Pipe/Tube Diameter. This allows for the inspection gauge to fit between two connections for inspection and proper operation of the fitting. It must also be noted that no fitting can be installed within the radius of a bend and only straight pipe section can be used.

Installation Procedures

Coupling Position and Alignment

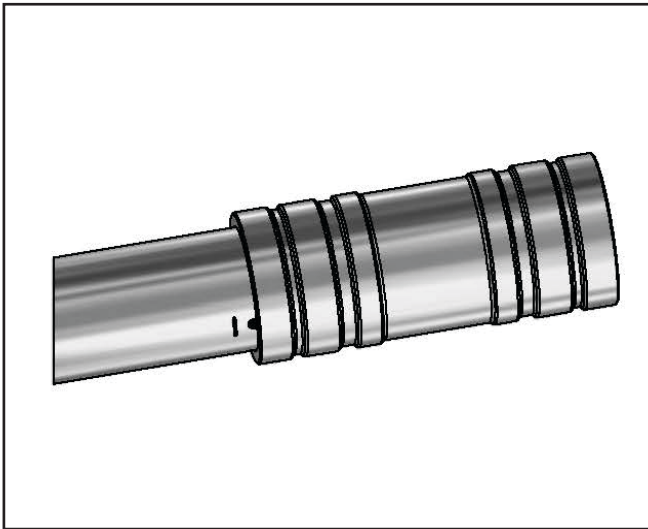

- Slide the coupling on to the end of pipe to first mark which is oval shaped.
- The edge of the coupling must touch any part of the oval mark.

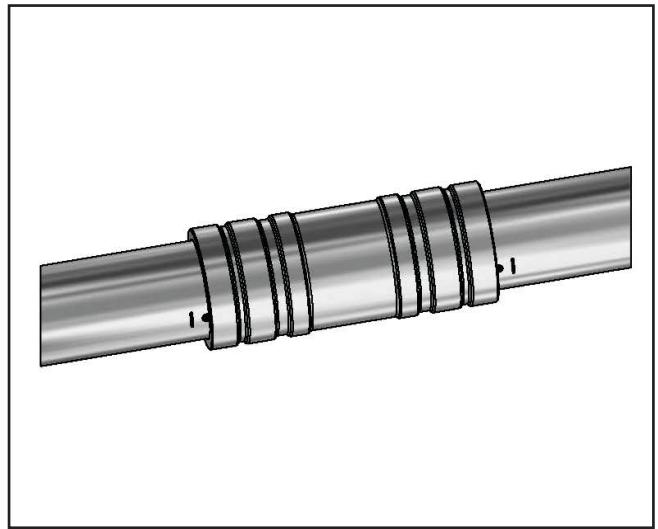

- Insert end of other pipe into coupling so the ends of pipe touch inside of the coupling.
- The markings should be visible as shown.

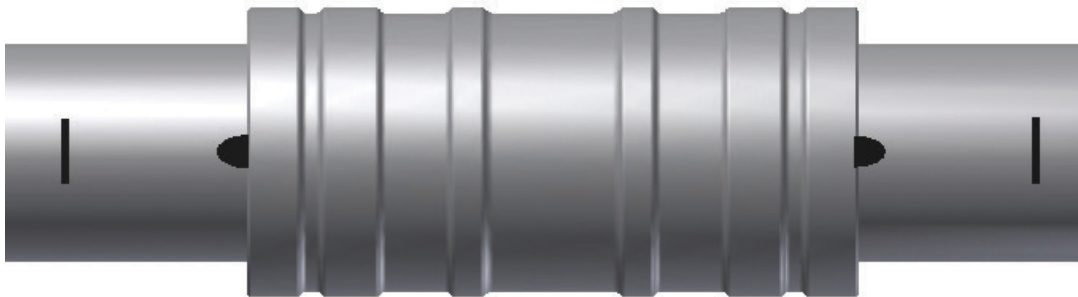

Installation Procedures

Swage Sequence

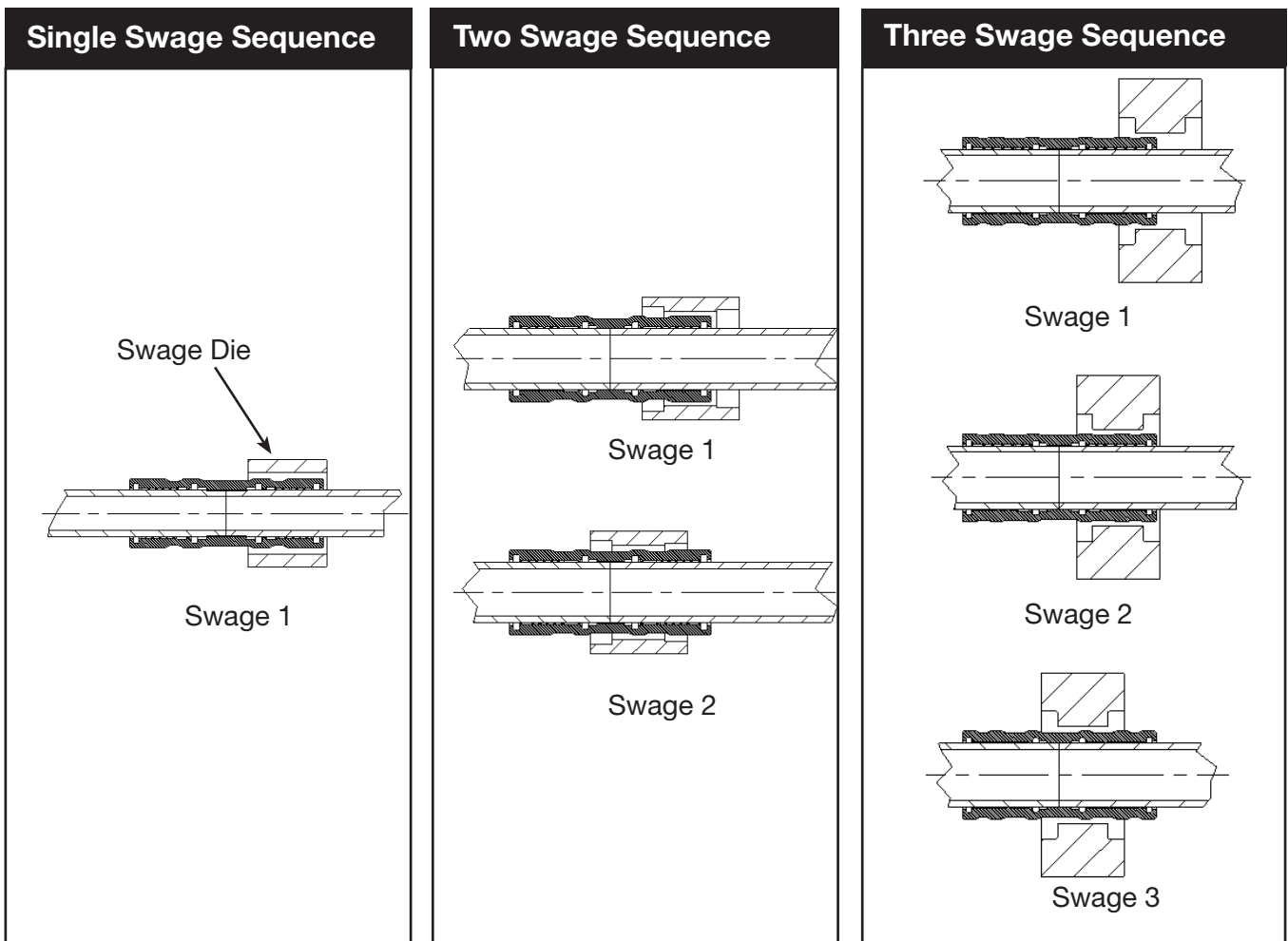

- All raised surfaces on coupling must be swaged.
- Swaging order is shown above for 1 swage, 2 swage and 3 swage configurations which varies by fitting size, series and tool model.
- Always start with the outside swage first and work towards the middle of the coupling.

Note: For heavy wall pipe and duplex/super duplex fittings two swages maybe required per band. Swage at location, rotate PYPLOK® Tool 90° and swage again. This is only required if the inspection gauge does not pass over the swage band after original swage or for low pressure gas applications.

Installation Procedures

Tool Operation and Die Engagement

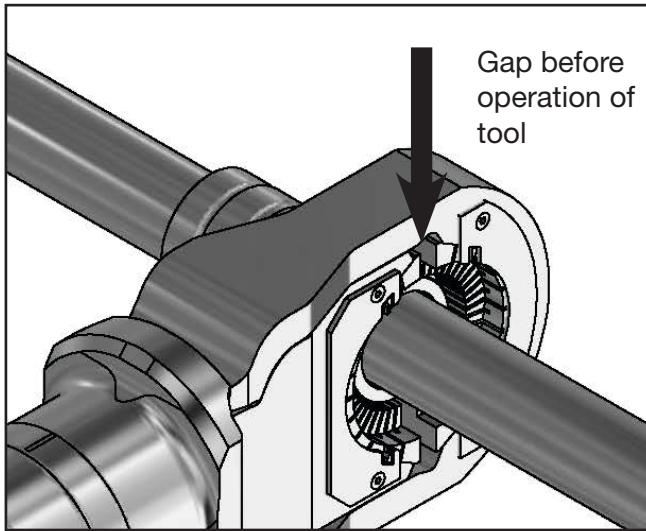

- Before swaging notice the gap between head assemblies.
 - The hydraulic power pack being electric, hand and or pneumatic are required to produce the required pressure and oil flow for the PYPLOK® Tool to operate.
 - Note that the PYPLOK® Tooling does not have noise emission >70dB(A).

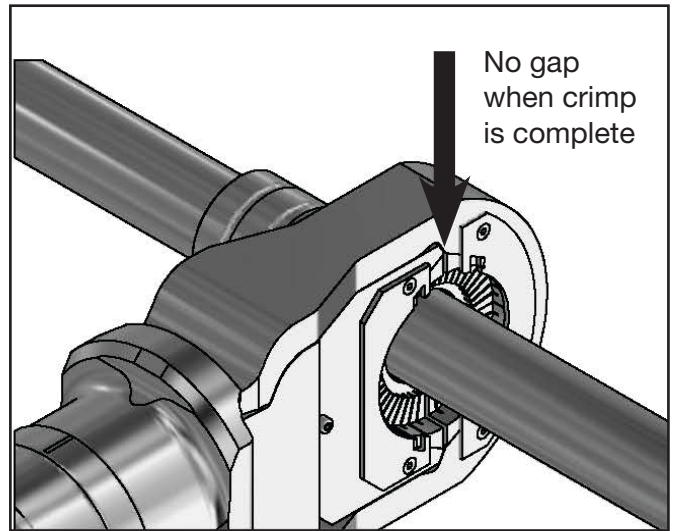

- To swage; turn on the power pack. The pressure from the power unit forces the lower die block and upper head assembly together thus swaging the fitting on the pipe or tube.
- The swage is complete when the head bottoms out and the gap closes.
- In cases where a pump with a 10,000 PSI/ 690 bar relief is available, the tool will stop crimping and retract once 10,000 PSI/ 690 bar is achieved.

Installation Procedures

Swage Inspection and Assembly

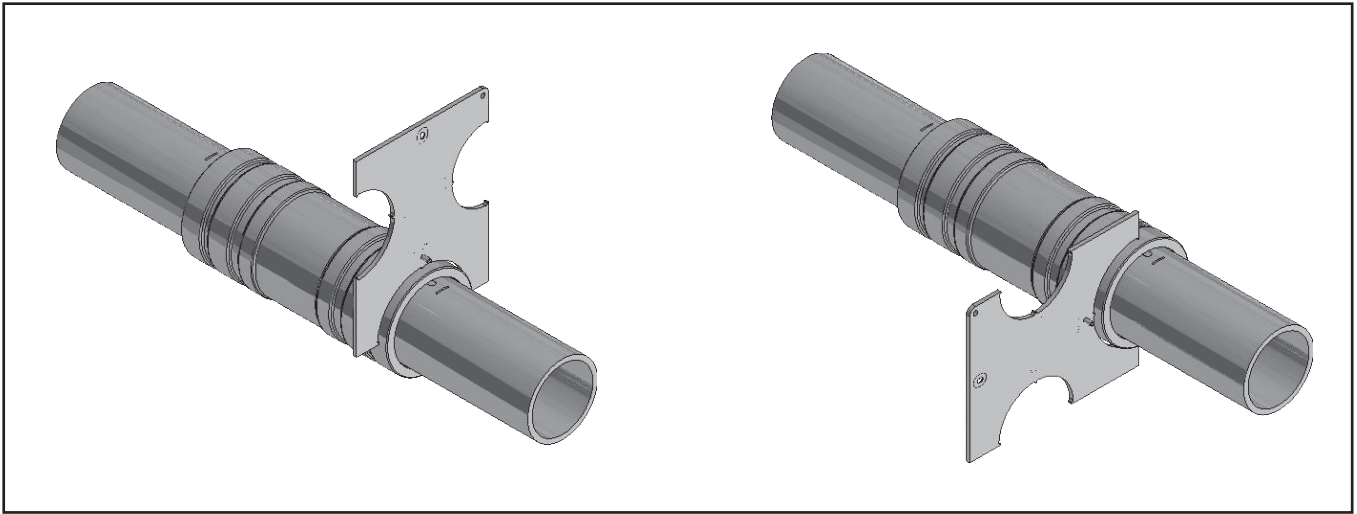

- Each swage band must be checked with the corresponding inspection gauge.
- The inspection gauge must fit freely around each swage band at two locations 90° from each other.

Acceptable Crimp

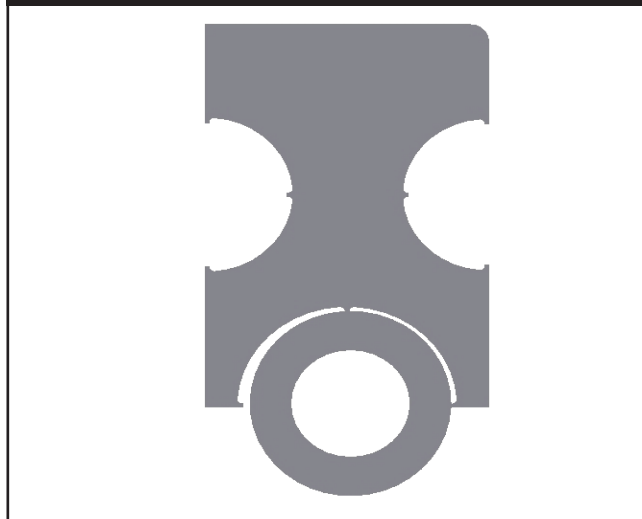

- 2 Point Contact, 90° Apart
- Acceptable Crimp

Unacceptable Crimp

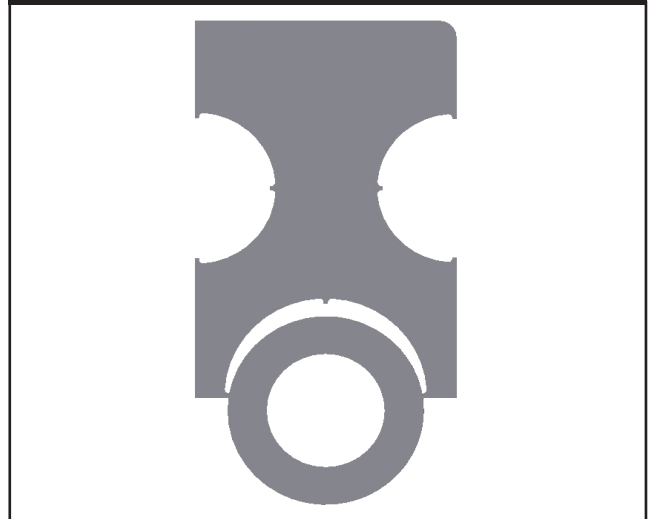

- 2 Point Contact, 180° Apart
- Indicates that diameter of fitting is oversized and need re-crimping

- If any area of the swage bands does not pass the inspection gauge the fitting must be re-swaged.
- It may be required to re-swage and then rotate the tool 90° and re-swage in certain situations.
- After re-swaging the fitting must be checked with the inspection gauge as per the above process.

Installation Procedures

Swage and Installation Inspection

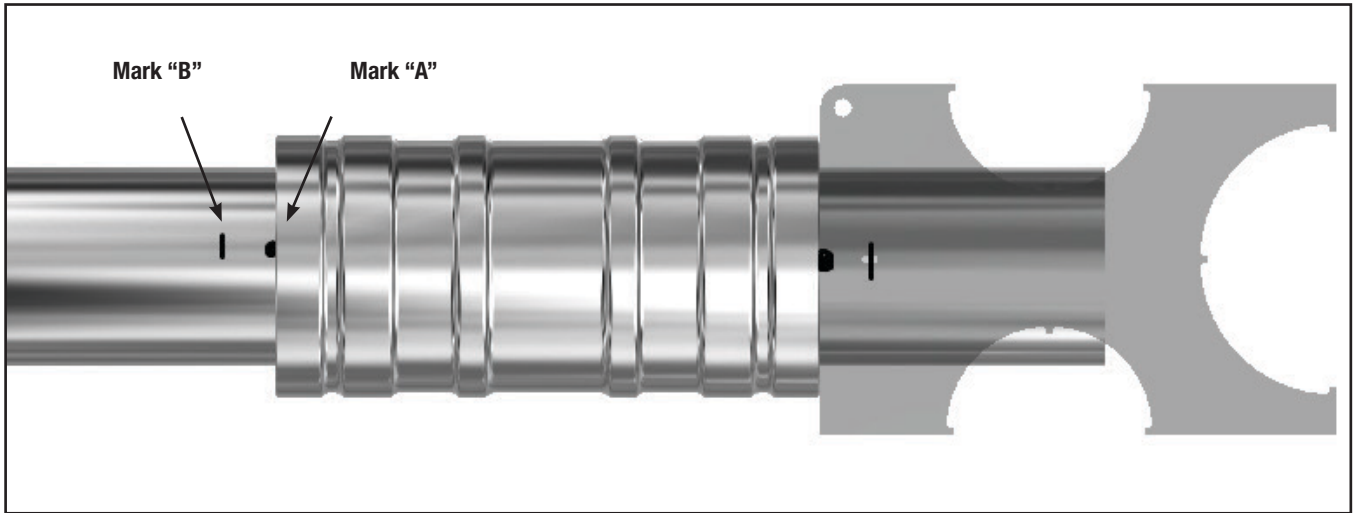

- Verify pipe insertion by observing that some portion of the pipe installation Mark "A" is beneath the fitting and that some portion of the mark is visible.
- In the event that the installation Mark "A" is not clearly visible, the inspection Mark "B" can be used to verify proper insertion.
- Position the marking tool against the fitting end, placing the side with the pin stop away from the pipe and verify that some portion of the inspection Mark "B" is visible in the gauge window or between the slot and the fitting end.

PYPLOK® Limited Warranty

TUBE-MAC® PIPING TECHNOLOGIES LTD. WARRANTS ITS PRODUCTS TO BE FREE FROM VISIBLE DEFECTS IN MATERIALS AND WORKMANSHIP FOR A PERIOD OF ONE (1) YEAR FOLLOWING THE DATE OF DELIVERY TO THE ORIGINAL BUYER. THE WARRANTY EXTENDS ONLY TO THE ORIGINAL BUYER.

TUBE-MAC® PIPING TECHNOLOGIES LTD. makes no warranty, express or implied, as to the merchantability or fitness for a particular purpose except as stated in this Warranty.

This Warranty shall be in lieu of any other Warranty, whether express or implied, by this Agreement or at law or in equity or by any statute or otherwise. The Buyer agrees that the foregoing shall be pleaded by TUBE-MAC® PIPING TECHNOLOGIES LTD. as an estoppel in any action brought by the Buyer against TUBE-MAC® PIPING TECHNOLOGIES LTD.

The Buyer agrees that porosity or pin holes in steel may not be commercially detectable. Therefore, TUBE-MAC® PIPING TECHNOLOGIES LTD. offers no warranty with respect to steel integrity and TUBE-MAC® PIPING TECHNOLOGIES LTD. shall not be liable for any damages, claims, injuries or otherwise caused by or in any way related to steel integrity.

TUBE-MAC® PIPING TECHNOLOGIES LTD. liability shall be limited to the repair or replacement of defective product(s) free of charge at the seller's sole option and discretion. TUBE-MAC® PIPING TECHNOLOGIES LTD. reserves the right at its sole option and discretion to refund a portion or all of the purchase price paid by the Buyer in lieu of any other obligations TUBE-MAC® PIPING TECHNOLOGIES LTD. has under this Warranty. In no event shall TUBE-MAC® PIPING TECHNOLOGIES LTD. be liable for any incidental, consequential, general or special damage of any kind or nature whatsoever including but not limited to loss of profit arising out of any incident(s) involving the use or utilization of the product and/or system covered under this Warranty. In no event shall TUBE-MAC® PIPING TECHNOLOGIES LTD. be liable for any personal injury or any special or general damages arising out of the personal injury of any kind or nature whatsoever.

TUBE-MAC® PIPING TECHNOLOGIES LTD. shall not be liable under this Warranty or otherwise if damages to the product are caused as a result of any type of accident or in the event the product and/or system was subject to alteration, abuse, misuse, extraordinary use of any kind whatsoever, improper maintenance or operation or improper or unauthorized repair.

TUBE-MAC® PIPING TECHNOLOGIES LTD. makes no warranty whatsoever as to any product and/or system covered by this Warranty which has been repaired or altered by anyone other than TUBE-MAC® PIPING TECHNOLOGIES LTD. or authorized personnel.

TUBE-MAC® PIPING TECHNOLOGIES LTD. neither assumes nor authorizes any person to assume for it any other liability in connection with the sale of such products and/or systems.

WARNING: Failure or improper selection or improper use of the products and/or systems described herein or related items can cause death, personal injury and property damage.

PYPLOK®

GLOBAL HEADQUARTERS:

TUBE-MAC® PIPING TECHNOLOGIES LTD.
853 Arvin Avenue
Stoney Creek, Ontario L8E 5N8
Canada
Tel: +1 905-643-8823



TUBE-MAC® INDUSTRIES INC.
420 Halstead Blvd.
Zelienople, Pennsylvania
USA 16063
Tel: (724) 473-0823

TUBE-MAC® INDUSTRIES
(SERVICES) INC.
5201 Orchard Road
Pascagoula, Mississippi
USA 39568
Tel: (228) 762-1732

TUBE-MAC® PIPING
TECHNOLOGIES, S.L.
Avenida Sierra de
Guadarrama, 14
28691 Villanueva de la Cañada
Madrid, Spain
Tel: +34 91 813 50 50
Fax: +34 91 182 25 51

TUBE-MAC® PIPING
TECHNOLOGIES GMBH.
Egon-Schiele-Str. 1
A-4614 Marchtrenk
Austria
Tel: +43 (0) 7243 51200



For more information please contact
Tube-Mac® or your local distributor

